



# DIAMOND VANTAGE

PRODUCT CATALOG | 14TH EDITION



Since 2003, Diamond Vantage has been serving the construction and stone industries with diamond tools that yield the highest level of performance. From its inception, Diamond Vantage has been working to become the BEST supplier to our customer by continuing to upgrade in all areas of our product line and customer services.

We have our most exciting product lineup to date, and have included all our new products in this beautiful catalog. We have made great strides to make the catalog more useful than ever. Grades, bonds, and other specifications are all clearly presented for each product.

Diamond Vantage diamond tools are used in all areas, from highways to bridges to buildings, and everywhere in-between. We continue to strive towards becoming the leader in diamond tool manufacturing by providing our customers with the BEST quality and service, exceeding industry expectations. Diamond Vantage manufactures a complete range of construction diamond tools designed for maximum performance. Such products include: flat saw blades, wall saw blades, hand saw blades, small diameter blades, diamond wire, cup wheels, core bits, specialty products and much more!

#### **TRUTH IN ENGINEERING**

What sets Diamond Vantage apart from most of its competition is that we are a true manufacturer. Unlike most of our competition, we manufacture 100% of the diamond tools we sell.

- The result is quality, consistency, innovation, and competitive pricing.
- Experienced product engineers for technical support and problem solving.
- Manufacture a full range of diamond tools.
- Engineered to reduce customer operating costs.

#### **TRUTH IN MARKETING**

- Extensive national sales & marketing support.
- Complete sales support and training.

#### **TRUTH IN SOLUTIONS**

- Large inventory for quick turnaround.
- Private label & co-branding.
- Incentive programs tailored to meet each customer's request and needs.

#### **TRUTH IN VALUE**

- Industry leader in innovation.
- Lowest standard pricing in the industry.



**BRANDS WE OFFER / 004**  
ZENESIS™, DiamondX®, Equipment



**HOW DIAMOND BLADES WORK / 005**



**CHOOSE FROM THOUSANDS OF SPECS / 006**



**UNDERSTANDING THE AGGREGATES / 007**



**CHOOSING THE PROPER BLADE SEGMENTS / 008**



**TROUBLE SHOOTING, POLICIES, TERMS/CONDITIONS & WARRANTY / 107**



**PROMOTION ITEMS / 112**  
DV Display Rack, DV Water Bottle, DV Hat, DV Safety Shirt, DV Counter Mat, DV Pen & Note Pad



**PROFESSIONAL SERIES / 009 (35-120 HP)**  
Flat Saw Blades & Wall Saw Blades for Concrete, Asphalt and Asphalt Overlay



**SPECIALTY PRODUCTS / 020**  
Pavement Grinding, Diamond Wire, Ring Saw Blades, All-Cut Blades, Ductile Iron Blades



**CORE DRILLING / 025**  
Wet & Dry Bits for Concrete, Masonry, General Purpose and Asphalt, Extensions, Adapters



**EARLY ENTRY, GREEN CONCRETE / 031**  
Green Concrete Blades, Shields and Skid Plates



**HIGH SPEED • MASONRY LOW HP FLAT SAW BLADES / 036**  
For Hard Materials, General Purpose, Concrete, Asphalt, Abrasive Materials and All-Purpose



**SURFACE PREP, F.A.S.T. & CONCRETE POLISHING PRODUCTS / 049**  
Cup Wheels, Grinding Blocks, Grinding Wheels, Grinding Heads, F.A.S.T. System, Polishing Pads



**SMALL DIAMETER / 059**  
For Hard Materials, General Purpose, Abrasive Materials and All-Cut



**TUCK POINT • CRACK CHASER / 067**

Standard, Double & Triple  
Tuck Point Blades; V-Shaped and Turbo Crack Chasers



**TILE BLADES / 071**

For Ceramic, Porcelain (Wet & Dry), Glass, General Purpose & Core Bits



**STONE PRODUCTS / 078**

Turbo Rim Blades, Polishing Pads, Cup Wheels, Core/Finger Bits, Pin Drills,  
Shaping Tools, Bridge Saw Blades, Cutter Grinder, Profile Wheel, Diamond Hand Pad



**METAL CUTTING / 093**

















Chopper, Cutter (Type 1), Depressed Center (Type 29), Pipeline Disc (Type 27),  
Foundry Disc, Cutting Grinding Wheel, Hard Facing Welding



**EQUIPMENT / 099**

Low HP Saws (FS200-13H), Masonry Saws (MDE350), Core Drills (SMD08, SMD12,  
DRE4, DRE4 Stand), Concrete Grinding (FG7500, FG5000, DC3300, DC350LM,  
EG1000, DV Hand Grinder)

**\* DESCRIPTION OF ICONS**

 angle grinder (small)	 angle grinder (large)	 bridge saw	 CNC machine	 circular saw	 core rig
 high hp walk-behind	 low hp walk-behind	 high speed saw	 masonry saw	 ring saw	 tile saw
 wall saw	 wet use	 dry use	 made in USA		

## ZENESIS™ TECHNOLOGY



### WORLD'S MOST ADVANCED PATTERNED DIAMOND TECHNOLOGY GETS EVEN BETTER.

- Hybrid Layering Technology maximizes exposed diamonds.
- Maximizes product consistency.
- Significantly improves both cutting speed and blade life.
- Enables cost-effective mass production.
- Protected by patented technologies.



## DIAMOND<sup>®</sup>

### NEW DIAMOND TOOLS FOR DEMANDING METAL-WORKING APPLICATIONS

DiamondX<sup>®</sup> is a new generation of tools for the metal-working industry. DiamondX<sup>®</sup> concentrates a large number of diamond grits on a single layer with an incredibly strong bond. This technology allows DiamondX<sup>®</sup> to cut and grind materials that traditional diamond tools could not.

#### Applications:

- High & Low Carbon Steel
- Hard Facing Alloys
- Ductile Iron
- Rail Track
- Steel Section, Bar & Tube
- Wood, Plastic, FRP, PVC

## DIAMOND VANTAGE EQUIPMENT



**Haken**

**GorillaConcreteTools**

Diamond blades contain industrial-grade diamonds embedded in segments or rims on their cutting edge. As the blade is used, the abrasive qualities of the material being cut (such as concrete) wears down the segment. Diamond crystals either get crushed or let loose as the metal matrix gets worn away, exposing new diamonds to continue the cutting.

The abrasive quality of the material being cut is a large factor in choosing the correct blade for a job. Harder materials, such as cured concrete, require a blade with a softer metal mix. This softer mix will ensure adequate erosion of the segment bringing new diamond to the surface at the optimum rate.

Soft materials such as green concrete and asphalt tend to wear down segments faster. Therefore, segments with a harder, more wear-resistant metal mix in the segment, provide longer blade life and overall better performance.

Abrasive materials tend to erode the metal core, or center, of diamond blades causing undercutting. Undercutting is usually concentrated on part of the core that attaches to the segment. If undercutting is excessive, it can cause segment loss and damage the blade. Diamond Vantage offers 3 types of undercut protection which reduce abrasive slurry accumulation beneath the segments to provide extended blade life.

Segments come in different heights. The total segment height is not as important as the diamond depth – the portion of the segment that contains diamonds. The diamond depth combined with diamond concentration and quality determines the overall performance value of the blade.

The accompanying chart shows the effect different variables have on a diamond blade cutting speed and blade life.

## WHAT TO CONSIDER AND WHEN CHOOSING A DIAMOND BLADE

### WHAT IS THE MATERIAL?

Brick?  
Block?  
Combination of Brick and Block?  
Green Concrete?  
Cured Concrete?  
Asphalt?

### WHAT IS THE CUTTING METHOD?

Wet or Dry?

### WHAT KIND OF EQUIPMENT IS BEING USED?

High speed hand held saw?  
Masonry table type saw?  
Walk behind saw? (low or high hp)  
Hand held power tool?

### HOW DEEP IS THE CUT?

Use proper blade diameter for depth required.  
(remember, a 5" cut requires a 14" blade.)

### HOW BIG IS THE JOB?

Higher quality blades are more economical to use.

### DIAMOND BLADE CUTTING PERFORMANCE VARIABLES

Variables	Change	Result	
		Cutting Speed	Blade Life
Segment Bond Hardness	Harder	Slower	Longer
	Softer	Faster	Shorter
Segment Width	Thinner	Faster	Shorter
	Thicker	Slower	Longer
Material Hardness	Harder	Slower	Longer
	Softer	Faster	Shorter
Material Abrasiveness	More	Faster	Shorter
	Less	Slower	Longer
Material Steel Reinforcing	Less	Faster	Longer
	More	Slower	Shorter
Material Aggregate Size	Smaller	Faster	Shorter
	Larger	Slower	Longer
Horsepower	Lower	Slower	Longer
	Higher	Faster	Shorter
Blade Speed RPM	Lower	Faster	Shorter
	Higher	Slower	Longer
Water Volume	Lower	Faster	Shorter
	Higher	Slower	Longer
Cutting Pressure	Lower	Slower	Shorter
	Higher	Faster	Longer
Cutting Depth	Shallow	Faster	Longer
	Deep	Slower	Shorter

## DIAMOND BLADE CUTTING DEPTH AND SPEED

The actual cutting depth may vary depending on a number of factors, including the exact blade diameter, the exact flange diameter, saw components, etc.

**Warning:** Operating at greater than the max RPM can cause blade damage, which may cause injury.

Blade Size (in.)	Cutting Depth by Application (in.)					Speed	
	Flat Saw	Wall Saw	Masonry	High Speed	Tile	Rec. RPM	Max. RPM
4	-	-	-	-	3/4	9072	15000
4 1/2	-	-	-	-	1	8063	13300
5	-	-	-	-	1 1/4	7257	12000
6	-	-	-	-	1 3/4	6048	10185
7	1 1/2	-	-	-	2 1/4	5184	8730
8	2	-	-	-	2 3/4	4536	7640
9	-	-	-	-	3 1/4	4032	6790
10	3	-	-	-	3 3/4	3629	6115
12	3 5/8	-	-	-	-	3024	5095
12HS*	-	-	-	4	-	-	6300
14	4 5/8	4 5/8	5	-	-	2592	4365
14HS*	-	-	-	4 5/8	-	-	5460
16	5 5/8	-	6	-	-	2268	3820
16HS*	-	-	-	6	-	-	4725
18	6 5/8	6 1/2	7	-	-	2016	4500
20	7 5/8	-	8-	-	-	1814	3055
20 5/8	-	-	8+	-	-	1814	3055
24	9 5/8	9 1/2	-	-	-	1512	2550
26	10 5/8	-	-	-	-	1396	2350
30	11 3/4	11 1/2	-	-	-	1120	2040
36	14 3/4	14 1/2	-	-	-	1008	1700
42	17 3/4	17 3/4	-	-	-	864	1455
48	19 3/4	20 3/4	-	-	-	756	1275

\* Rec. - Recommended

\*\*HS - High Speed Diamond Blades

	CRITICALLY HARD	HARD	MEDIUM	SOFT	GREEN (<48 hrs old)
<b>HARDNESS</b>	8000 PSI (Power Plants)	6000 - 8000 PSI (Bridges & Airport Runways)	4000 - 6000 PSI (Highways & Walks)	2000 - 4000 PSI (Patio/Walks)	less than 2000 PSI
<b>AGGREGATE TYPE</b>	Flint, Chert, Basalt, Trap Rock, Quartz	River Rock, Quartz, Some Granite, Schist	Some Limestone, Some Granite, Dolomite, Some Marble	Sandstone, Some Limestone & Some Marble	Can be any combination of rocks determined by end-product usage
<b>AGGREGATE SIZES</b>	+1 1/2" Sieved Gravel	← Range →			Pea Gravel (approx. 1/4" diameter)
<b>SAND</b>	<b>Round (Low Abrasion)</b>	← Range →			<b>Sharp (High Abrasion)</b>
		<ul style="list-style-type: none"> <li>• Processed sand normally "sharp"</li> <li>• River sand normally "round"</li> </ul>			
<b>STEEL REINFORCING</b>	<b>Heavy</b> <ul style="list-style-type: none"> <li>• #4 rebar (1/2")</li> <li>• #5 rebar (5/8")</li> <li>• Multi mat wire mesh</li> </ul>	<b>Medium</b> <ul style="list-style-type: none"> <li>• Multi mat wire mesh</li> <li>• #4 rebar (1/2")</li> </ul>	<b>Light</b> <ul style="list-style-type: none"> <li>• Single mat wire mesh</li> </ul>		
<b>BLADE OR CORE BIT BOND HARDNESS SELECTION</b>	<b>Soft Bond</b> <span style="color: red;">→</span> <span style="color: blue;">→</span> <b>Hard Bond</b>				

### AGGREGATE MAP

The map shows typical aggregate hardnesses for the areas represented.

- Soft
- Medium Soft
- Medium
- Medium Hard
- Hard

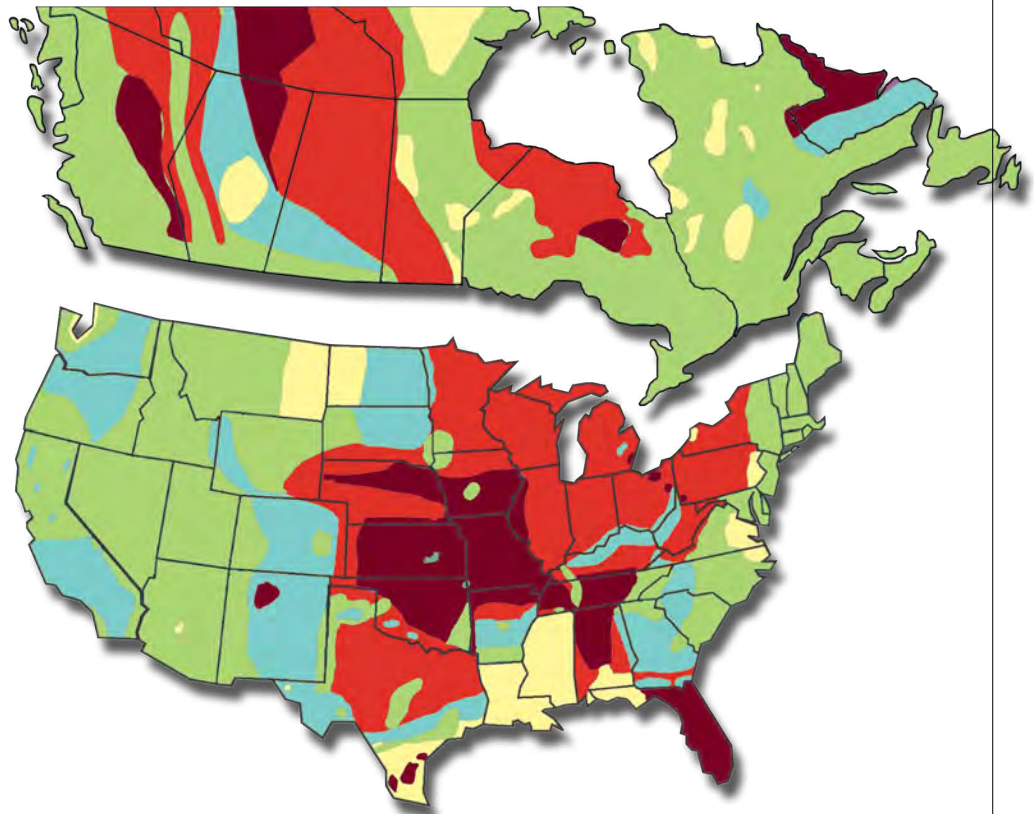



## DIAMOND BLADE SEGMENT/RIM SAMPLE CHART

Diamond blades come in many different segment and rim configurations. This chart may help to show the various types of products available and to simplify, for the user, the selection of what will best serve the desired application. The actual application will determine the final product specification, shape, and size.

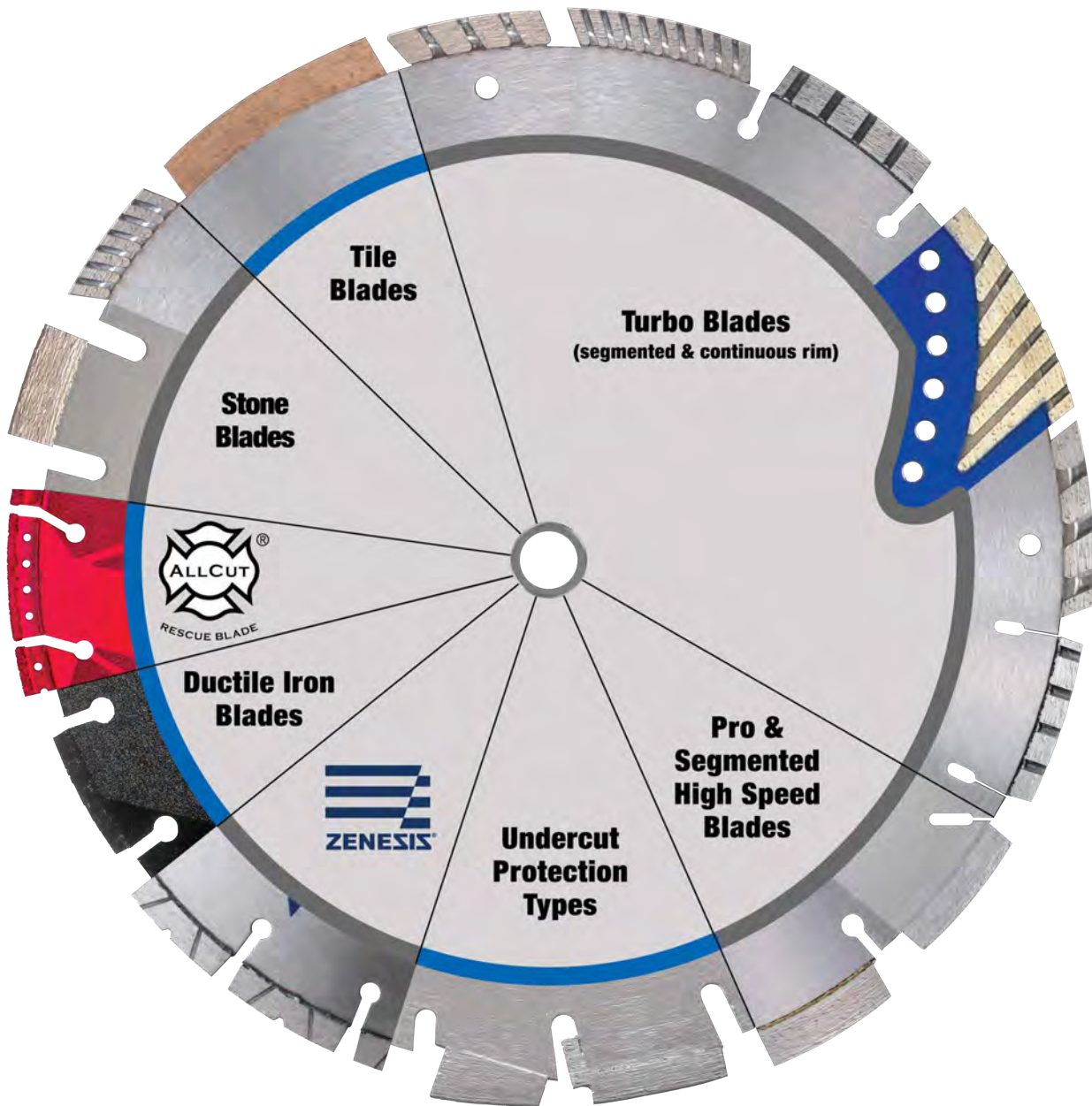



# PROFESSIONAL SERIES

### PART NUMBER CHART

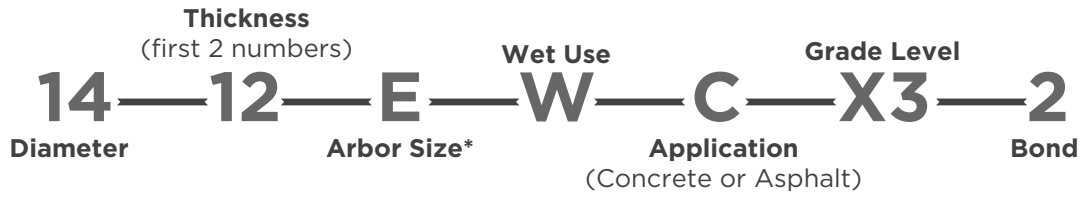

\*Custom arbor sizes available by request

### PROFESSIONAL BLADES PERFORMANCE CHART

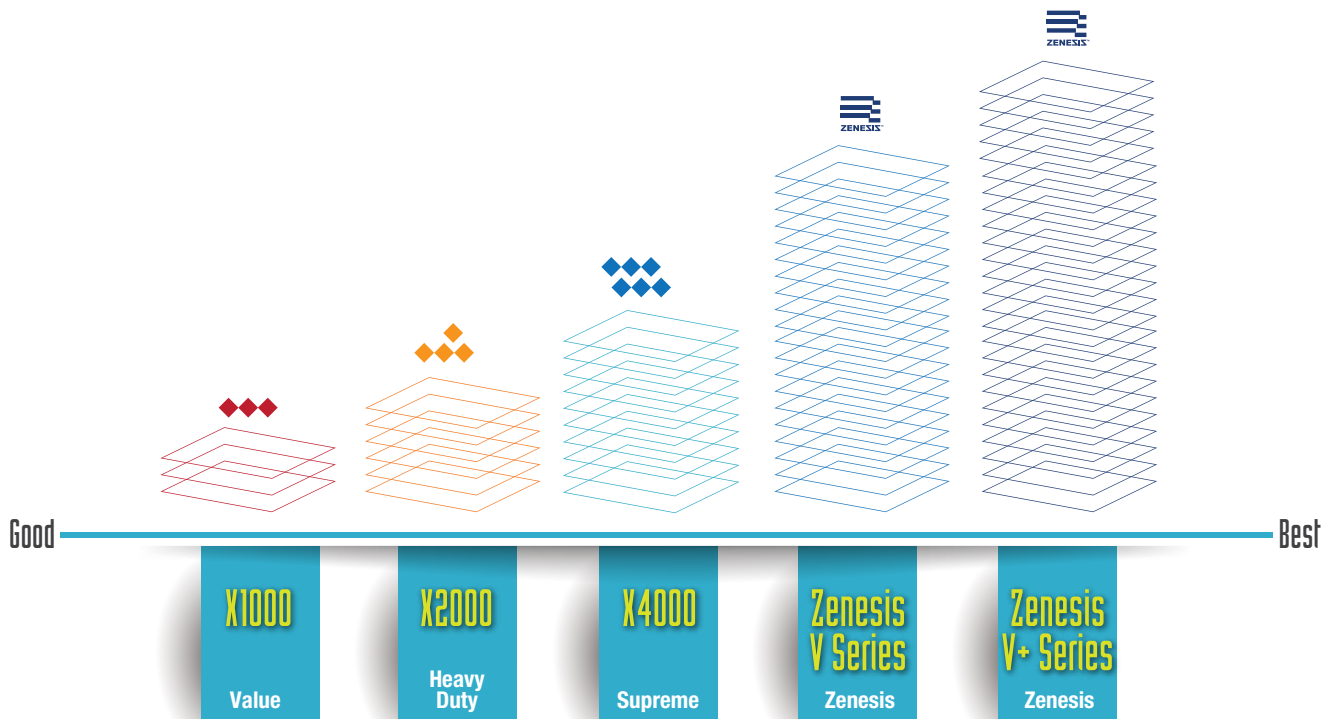

## BOND/SEGMENT HARDNESS

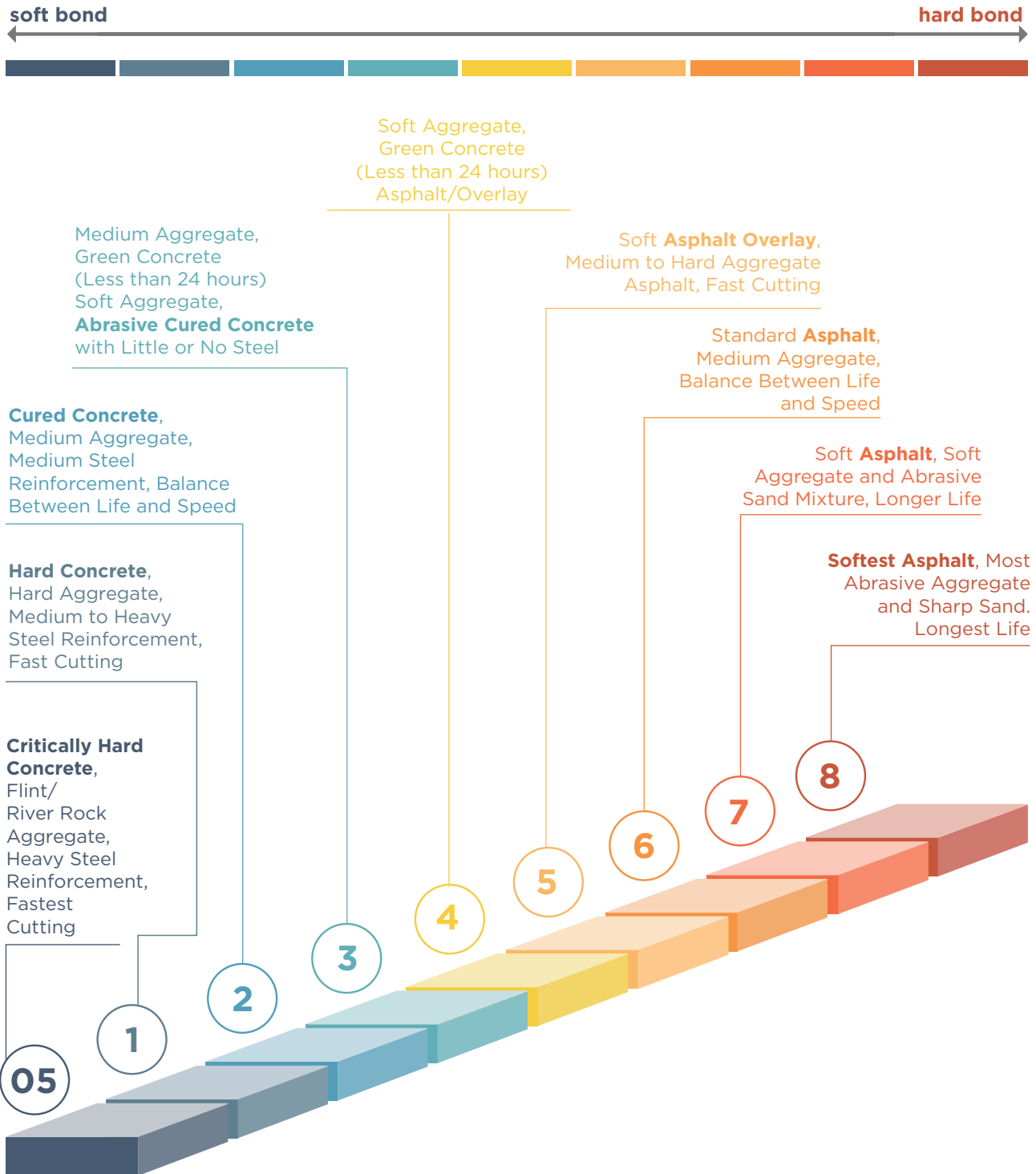

## BOND SELECTION CHART (CONCRETE)

**Critically Hard Concrete,**  
Flint/River Rock  
Aggregate, Heavy Steel  
Reinforcement, Fastest  
Cutting

**Cured Concrete,**  
Medium Aggregate,  
Medium Steel  
Reinforcement, Balance  
Between Life and Speed

Soft Aggregate,  
Green Concrete  
(Less than 24 hours)  
Asphalt/Overlay

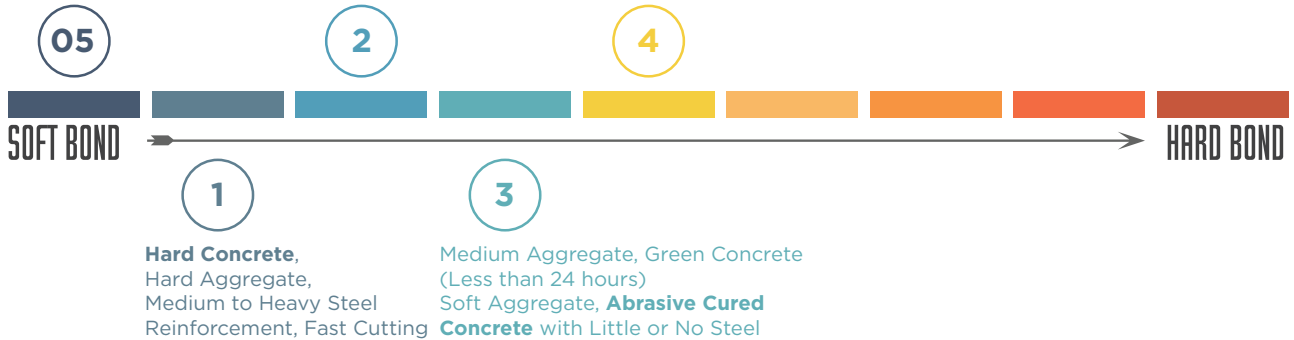

**X1000**  
concrete

**STANDARD BLADE**

- 10mm (.394") segment height
- Most economical version of our professional series blades (not for machines over 65HP)



**X2000**  
concrete

**STANDARD PLUS BLADE**

- 10mm (.394") segment height
- Balance between cost and performance (not for machines over 65HP)



**X4000**  
concrete

**SUPREME BLADE**

- 10mm (.394") segment height
- Utilizes our highest quality diamond for maximum performance
- Highly recommended for machines 65HP and larger



**X1000**

SIZE	PART #	LIST PRICE
12" x .125 x 1	1212EWCX0	\$463.40
12" x .155 x 1	1215EWCX0	\$550.12
12" x .187 x 1	1218EWCX0	\$620.27
12" x .250 x 1	1225EWCX0	\$732.33
12" x .375 x 1	1237EWCX0	\$823.18
12" x .500 x 1	1250EWCX0	\$1,128.47
14" x .125 x 1	1412EWCX0	\$527.88
14" x .140 x 1	1414EWCX0	\$601.21
14" x .155 x 1	1415EWCX0	\$644.99
14" x .165 x 1	1416EWCX0	\$674.44
14" x .187 x 1	1418EWCX0	\$723.47
14" x .250 x 1	1425EWCX0	\$863.35
14" x .310 x 1	1431EWCX0	\$1,093.04
14" x .375 x 1	1437EWCX0	\$1,113.84
14" x .500 x 1	1450EWCX0	\$1,325.71
16" x .125 x 1	1612EWCX0	\$619.85
16" x .140 x 1	1614EWCX0	\$707.10
16" x .155 x 1	1615EWCX0	\$757.77
16" x .187 x 1	1618EWCX0	\$854.90
16" x .250 x 1	1625EWCX0	\$984.99
16" x .375 x 1	1637EWCX0	\$1,319.33
18" x .125 x 1	1812EWCX0	\$732.85
18" x .140 x 1	1814EWCX0	\$837.49
18" x .155 x 1	1815EWCX0	\$893.94
18" x .165 x 1	1816EWCX0	\$926.49
18" x .187 x 1	1818EWCX0	\$1,014.65
18" x .210 x 1	1821EWCX0	\$1,068.52
18" x .250 x 1	1825EWCX0	\$1,176.98
18" x .375 x 1	1837EWCX0	\$1,493.50
20" x .125 x 1	2012EWCX0	\$847.48
20" x .140 x 1	2014EWCX0	\$923.50
20" x .155 x 1	2015EWCX0	\$1,006.00
20" x .165 x 1	2016EWCX0	\$1,046.07
20" x .187 x 1	2018EWCX0	\$1,132.18
24" x .125 x 1	2412EWCX0	\$1,033.61
24" x .140 x 1	2414EWCX0	\$1,130.73
24" x .155 x 1	2415EWCX0	\$1,219.31
24" x .165 x 1	2416EWCX0	\$1,254.64
24" x .187 x 1	2418EWCX0	\$1,377.93
24" x .210 x 1	2421EWCX0	\$1,521.52
24" x .250 x 1	2425EWCX0	\$1,669.32
26" x .155 x 1	2615EWCX0	\$1,484.44
26" x .165 x 1	2616EWCX0	\$1,522.34
26" x .187 x 1	2618EWCX0	\$1,648.93
30" x .155 x 1	3015EWCX0	\$1,830.31
30" x .165 x 1	3016EWCX0	\$1,873.16
30" x .175 x 1	3017EWCX0	\$2,016.02
30" x .187 x 1	3018EWCX0	\$2,041.25
30" x .210 x 1	3021EWCX0	\$2,188.65
30" x .250 x 1	3025EWCX0	\$2,386.51
36" x .175 x 1	3617EWCX0	\$2,587.46
36" x .187 x 1	3618EWCX0	\$2,671.51
36" x .210 x 1	3621EWCX0	\$2,807.47
36" x .250 x 1	3625EWCX0	\$3,076.40
42" x .187 x 1	4218EWCX0	\$3,533.93
42" x .210 x 1	4221EWCX0	\$3,791.95
42" x .250 x 1	4225EWCX0	\$4,058.61
48" x .187 x 1	4818EWCX0	\$3,940.78
48" x .210 x 1	4821EWCX0	\$4,329.50
48" x .250 x 1	4825EWCX0	\$4,684.85
54" x .187 x 1	5418EWCX0	\$5,423.26
54" x .210 x 1	5421EWCX0	\$5,793.75
60" x .210 x 1	6021EWCX0	\$6,729.61
60" x .250 x 1	6025EWCX0	\$8,197.98

**X2000**

SIZE	PART #	LIST PRICE
12" x .125 x 1	1212EWCX1	\$569.28
12" x .155 x 1	1215EWCX1	\$693.91
12" x .187 x 1	1218EWCX1	\$786.71
12" x .250 x 1	1225EWCX1	\$959.34
12" x .375 x 1	1237EWCX1	\$1,110.75
12" x .500 x 1	1250EWCX1	\$1,598.46
14" x .125 x 1	1412EWCX1	\$651.48
14" x .140 x 1	1414EWCX1	\$759.73
14" x .155 x 1	1415EWCX1	\$812.77
14" x .165 x 1	1416EWCX1	\$845.73
14" x .187 x 1	1418EWCX1	\$917.63
14" x .250 x 1	1425EWCX1	\$1,128.16
14" x .310 x 1	1431EWCX1	\$1,490.72
14" x .375 x 1	1437EWCX1	\$1,519.97
14" x .500 x 1	1450EWCX1	\$1,873.06
16" x .125 x 1	1612EWCX1	\$761.07
16" x .140 x 1	1614EWCX1	\$888.89
16" x .155 x 1	1615EWCX1	\$949.45
16" x .187 x 1	1618EWCX1	\$1,076.97
16" x .250 x 1	1625EWCX1	\$1,287.71
16" x .375 x 1	1637EWCX1	\$1,783.45
18" x .125 x 1	1812EWCX1	\$891.77
18" x .140 x 1	1814EWCX1	\$1,041.54
18" x .155 x 1	1815EWCX1	\$1,109.62
18" x .165 x 1	1816EWCX1	\$1,146.70
18" x .187 x 1	1818EWCX1	\$1,264.43
18" x .210 x 1	1821EWCX1	\$1,363.62
18" x .250 x 1	1825EWCX1	\$1,517.50
18" x .375 x 1	1837EWCX1	\$2,015.71
20" x .125 x 1	2012EWCX1	\$1,059.36
20" x .140 x 1	2014EWCX1	\$1,135.37
20" x .155 x 1	2015EWCX1	\$1,248.15
20" x .165 x 1	2016EWCX1	\$1,288.22
20" x .187 x 1	2018EWCX1	\$1,434.89
24" x .125 x 1	2412EWCX1	\$1,280.81
24" x .140 x 1	2414EWCX1	\$1,377.93
24" x .155 x 1	2415EWCX1	\$1,501.84
24" x .165 x 1	2416EWCX1	\$1,537.17
24" x .187 x 1	2418EWCX1	\$1,731.12
24" x .210 x 1	2421EWCX1	\$1,910.03
24" x .250 x 1	2425EWCX1	\$2,163.72
26" x .155 x 1	2615EWCX1	\$1,913.33
26" x .165 x 1	2616EWCX1	\$1,951.13
26" x .187 x 1	2618EWCX1	\$2,153.42
30" x .155 x 1	3015EWCX1	\$2,316.26
30" x .165 x 1	3016EWCX1	\$2,359.11
30" x .175 x 1	3017EWCX1	\$2,459.13
30" x .187 x 1	3018EWCX1	\$2,587.77
30" x .210 x 1	3021EWCX1	\$2,803.25
30" x .250 x 1	3025EWCX1	\$3,129.76
36" x .175 x 1	3617EWCX1	\$3,134.81
36" x .187 x 1	3618EWCX1	\$3,293.73
36" x .210 x 1	3621EWCX1	\$3,566.79
36" x .250 x 1	3625EWCX1	\$3,994.55
42" x .187 x 1	4218EWCX1	\$4,240.20
42" x .210 x 1	4221EWCX1	\$4,556.21
42" x .250 x 1	4225EWCX1	\$4,996.94
48" x .187 x 1	4818EWCX1	\$4,848.83
48" x .210 x 1	4821EWCX1	\$5,305.74
48" x .250 x 1	4825EWCX1	\$5,865.34
54" x .187 x 1	5418EWCX1	\$6,432.25
54" x .210 x 1	5421EWCX1	\$6,878.34
60" x .210 x 1	6021EWCX1	\$7,922.66
60" x .250 x 1	6025EWCX1	\$8,578.87

**X4000**

SIZE	PART #	LIST PRICE
12" x .125 x 1	1212EWCX4	\$690.31
12" x .155 x 1	1215EWCX4	\$797.43
12" x .187 x 1	1218EWCX4	\$918.17
12" x .250 x 1	1225EWCX4	\$1,146.79
12" x .375 x 1	1237EWCX4	\$1,589.15
12" x .500 x 1	1250EWCX4	\$2,261.80
14" x .125 x 1	1412EWCX4	\$792.55
14" x .140 x 1	1414EWCX4	\$873.02
14" x .155 x 1	1415EWCX4	\$933.48
14" x .165 x 1	1416EWCX4	\$978.96
14" x .187 x 1	1418EWCX4	\$1,071.04
14" x .250 x 1	1425EWCX4	\$1,346.82
14" x .310 x 1	1431EWCX4	\$1,723.67
14" x .375 x 1	1437EWCX4	\$1,869.13
14" x .500 x 1	1450EWCX4	\$2,429.96
16" x .125 x 1	1612EWCX4	\$922.29
16" x .140 x 1	1614EWCX4	\$1,018.31
16" x .155 x 1	1615EWCX4	\$1,087.43
16" x .187 x 1	1618EWCX4	\$1,252.23
16" x .250 x 1	1625EWCX4	\$1,537.60
16" x .375 x 1	1637EWCX4	\$2,182.51
18" x .125 x 1	1812EWCX4	\$1,073.14
18" x .140 x 1	1814EWCX4	\$1,187.15
18" x .155 x 1	1815EWCX4	\$1,264.92
18" x .165 x 1	1816EWCX4	\$1,318.06
18" x .187 x 1	1818EWCX4	\$1,461.59
18" x .210 x 1	1821EWCX4	\$1,586.54
18" x .250 x 1	1825EWCX4	\$1,798.50
18" x .375 x 1	1837EWCX4	\$2,464.51
20" x .125 x 1	2012EWCX4	\$1,523.83
20" x .140 x 1	2014EWCX4	\$1,355.64
20" x .155 x 1	2015EWCX4	\$1,464.11
20" x .165 x 1	2016EWCX4	\$1,517.00
20" x .187 x 1	2018EWCX4	\$1,672.13
24" x .125 x 1	2412EWCX4	\$1,507.67
24" x .140 x 1	2414EWCX4	\$1,634.97
24" x .155 x 1	2415EWCX4	\$1,753.69
24" x .165 x 1	2416EWCX4	\$1,804.06
24" x .187 x 1	2418EWCX4	\$2,007.87
24" x .210 x 1	2421EWCX4	\$2,196.63
24" x .250 x 1	2425EWCX4	\$2,490.33
26" x .155 x 1	2615EWCX4	\$2,183.18
26" x .165 x 1	2616EWCX4	\$2,237.16
26" x .187 x 1	2618EWCX4	\$2,449.97
30" x .155 x 1	3015EWCX4	\$2,622.17
30" x .165 x 1	3016EWCX4	\$2,683.29
30" x .175 x 1	3017EWCX4	\$2,832.12
30" x .187 x 1	3018EWCX4	\$2,923.85
30" x .210 x 1	3021EWCX4	\$3,151.38
30" x .250 x 1	3025EWCX4	\$3,526.47
36" x .175 x 1	3617EWCX4	\$3,595.59
36" x .187 x 1	3618EWCX4	\$3,709.01
36" x .210 x 1	3621EWCX4	\$3,996.74
36" x .250 x 1	3625EWCX4	\$4,484.66
42" x .187 x 1	4218EWCX4	\$4,694.95
42" x .210 x 1	4221EWCX4	\$5,027.15
42" x .250 x 1	4225EWCX4	\$5,533.66
48" x .187 x 1	4818EWCX4	\$5,382.66
48" x .210 x 1	4821EWCX4	\$5,858.64
48" x .250 x 1	4825EWCX4	\$6,495.39
54" x .187 x 1	5418EWCX4	\$7,025.44
54" x .210 x 1	5421EWCX4	\$7,492.77
60" x .210 x 1	6021EWCX4	\$8,598.44
60" x .250 x 1	6025EWCX4	\$9,348.95

## PROFESSIONAL BLADES PERFORMANCE CHART

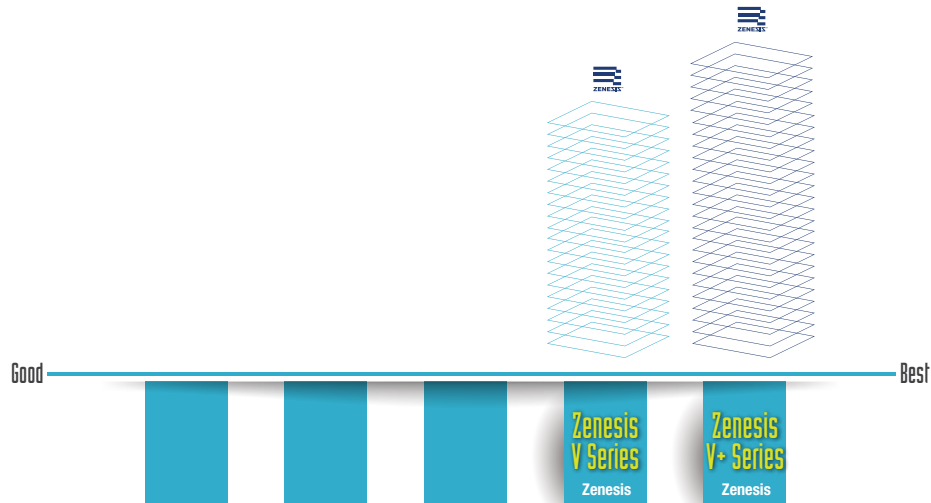

**ZENESIS™ V SERIES**  
35 con • concrete

- Features ZENESIS™, the most advanced diamond pattern for fast cutting through hard, reinforced concrete and long blade life.
- All-new 12mm segments are tuned for aggressive performance in hard aggregates
- Ideal for medium to high horsepower flat saws.



**ZENESIS™ V+ SERIES**  
35 con • concrete

- Features ZENESIS™, the most advanced diamond pattern for fast cutting through hard, reinforced concrete and long blade life.
- All-new 15mm are tuned for the fastest, most aggressive cutting in medium to hard aggregates and longer blade life.
- Ideal for high horsepower flat saws.



**ZENESIS™ V2 SERIES**  
40 & 50 con • concrete

- The new ZENESIS™ V2 series features a triangular structure and multi-diamond layers to control the exact time of diamond exposure, as well as the number of diamonds on the cut for uniform wear and optimum sawing performance. Field-test results have confirmed high cutting speed and long tool life on heavily reinforced concrete as well as overlay and other materials. A large selection of bond hardness and diamond concentrations are available to cover the majority of applications.



## V SERIES

SIZE	PART #	LIST PRICE
12" x .125 x 1	1212EVWZX4	\$625.90
12" x .155 x 1	1215EVWZX4	\$724.53
12" x .187 x 1	1218EVWZX4	\$876.72
12" x .250 x 1	1225EVWZX4	\$1,015.58
14" x .125 x 1	1412EVWZX4	\$717.47
14" x .140 x 1	1414EVWZX4	\$775.65
14" x .155 x 1	1415EVWZX4	\$834.34
14" x .165 x 1	1416EVWZX4	\$898.00
14" x .187 x 1	1418EVWZX4	\$992.08
14" x .250 x 1	1425EVWZX4	\$1,233.64
16" x .125 x 1	1612EVWZX4	\$836.52
16" x .140 x 1	1614EVWZX4	\$880.17
16" x .155 x 1	1615EVWZX4	\$967.36
16" x .187 x 1	1618EVWZX4	\$1,168.48
16" x .250 x 1	1625EVWZX4	\$1,394.74
18" x .125 x 1	1812EVWZX4	\$976.60
18" x .140 x 1	1814EVWZX4	\$1,061.95
18" x .155 x 1	1815EVWZX4	\$1,129.72
18" x .165 x 1	1816EVWZX4	\$1,226.00
18" x .187 x 1	1818EVWZX4	\$1,357.16
18" x .210 x 1	1821EVWZX4	\$1,489.50
20" x .125 x 1	2012EVWZX4	\$1,116.77
20" x .140 x 1	2014EVWZX4	\$1,203.88
20" x .155 x 1	2015EVWZX4	\$1,380.36
20" x .165 x 1	2016EVWZX4	\$1,441.25
20" x .187 x 1	2018EVWZX4	\$1,565.52
24" x .125 x 1	2412EVWZX4	\$1,347.74
24" x .140 x 1	2414EVWZX4	\$1,457.89
24" x .155 x 1	2415EVWZX4	\$1,662.21
24" x .165 x 1	2416EVWZX4	\$1,715.94
24" x .187 x 1	2418EVWZX4	\$1,885.02
24" x .210 x 1	2421EVWZX4	\$2,057.23
24" x .250 x 1	2425EVWZX4	\$2,338.31
26" x .155 x 1	2615EVWZX4	\$2,175.70
26" x .165 x 1	2616EVWZX4	\$2,240.61
26" x .187 x 1	2617EVWZX4	\$2,435.85
28" x .175 x 1	2817EVWZX4	\$2,717.26
30" x .155 x 1	3015EVWZX4	\$2,630.07
30" x .165 x 1	3016EVWZX4	\$2,703.73
30" x .175 x 1	3017EVWZX4	\$2,884.93
30" x .187 x 1	3018EVWZX4	\$2,924.19
30" x .210 x 1	3021EVWZX4	\$3,184.51
30" x .250 x 1	3025EVWZX4	\$3,652.50
36" x .155 x 1	3615EVWZX4	\$3,328.88
36" x .165 x 1	3616EVWZX4	\$3,419.85
36" x .175 x 1	3617EVWZX4	\$3,672.43
36" x .187 x 1	3618EVWZX4	\$3,720.11
36" x .210 x 1	3621EVWZX4	\$3,944.35
36" x .250 x 1	3625EVWZX4	\$4,627.60
42" x .187 x 1	4218EVWZX4	\$4,852.27
42" x .210 x 1	4221EVWZX4	\$5,097.87
42" x .250 x 1	4225EVWZX4	\$5,715.70
48" x .187 x 1	4818EVWZX4	\$5,465.22
48" x .210 x 1	4821EVWZX4	\$5,753.62
48" x .250 x 1	4825EVWZX4	\$6,742.08
54" x .187 x 1	5418EVWZX4	\$7,065.88
54" x .210 x 1	5421EVWZX4	\$7,730.63
60" x .210 x 1	6021EVWZX4	\$9,059.21

## V+ SERIES

SIZE	PART #	LIST PRICE
12" x .125 x 1	1212EVWZX5	\$782.38
12" x .155 x 1	1215EVWZX5	\$905.67
12" x .187 x 1	1218EVWZX5	\$1,095.90
12" x .250 x 1	1225EVWZX5	\$1,269.48
14" x .125 x 1	1412EVWZX5	\$896.83
14" x .140 x 1	1414EVWZX5	\$969.57
14" x .155 x 1	1415EVWZX5	\$1,042.93
14" x .165 x 1	1416EVWZX5	\$1,122.49
14" x .187 x 1	1418EVWZX5	\$1,240.10
14" x .250 x 1	1425EVWZX5	\$1,542.05
16" x .125 x 1	1612EVWZX5	\$1,045.66
16" x .140 x 1	1614EVWZX5	\$1,100.20
16" x .155 x 1	1615EVWZX5	\$1,209.20
16" x .187 x 1	1618EVWZX5	\$1,460.60
16" x .250 x 1	1625EVWZX5	\$1,743.43
18" x .125 x 1	1812EVWZX5	\$1,220.76
18" x .140 x 1	1814EVWZX5	\$1,327.44
18" x .155 x 1	1815EVWZX5	\$1,412.15
18" x .165 x 1	1816EVWZX5	\$1,532.50
18" x .187 x 1	1818EVWZX5	\$1,696.45
18" x .210 x 1	1821EVWZX5	\$1,861.88
20" x .125 x 1	2012EVWZX5	\$1,395.97
20" x .140 x 1	2014EVWZX5	\$1,504.85
20" x .155 x 1	2015EVWZX5	\$1,725.46
20" x .165 x 1	2016EVWZX5	\$1,801.55
20" x .187 x 1	2018EVWZX5	\$1,956.90
24" x .125 x 1	2412EVWZX5	\$1,684.68
24" x .140 x 1	2414EVWZX5	\$1,822.37
24" x .155 x 1	2415EVWZX5	\$2,077.76
24" x .165 x 1	2416EVWZX5	\$2,144.92
24" x .187 x 1	2418EVWZX5	\$2,356.28
24" x .210 x 1	2421EVWZX5	\$2,571.53
24" x .250 x 1	2425EVWZX5	\$2,922.89
26" x .155 x 1	2615EVWZX5	\$2,719.62
26" x .165 x 1	2616EVWZX5	\$2,800.76
26" x .187 x 1	2617EVWZX5	\$3,044.80
28" x .175 x 1	2817EVWZX5	\$3,396.58
30" x .155 x 1	3015EVWZX5	\$3,287.60
30" x .165 x 1	3016EVWZX5	\$3,379.66
30" x .175 x 1	3017EVWZX5	\$3,606.15
30" x .187 x 1	3018EVWZX5	\$3,655.24
30" x .210 x 1	3021EVWZX5	\$3,980.63
30" x .250 x 1	3025EVWZX5	\$4,565.63
36" x .155 x 1	3615EVWZX5	\$4,161.10
36" x .165 x 1	3616EVWZX5	\$4,274.82
36" x .175 x 1	3617EVWZX5	\$4,590.55
36" x .187 x 1	3618EVWZX5	\$4,650.13
36" x .210 x 1	3621EVWZX5	\$4,930.45
36" x .250 x 1	3625EVWZX5	\$5,784.50
42" x .187 x 1	4218EVWZX5	\$6,065.33
42" x .210 x 1	4221EVWZX5	\$6,372.33
42" x .250 x 1	4225EVWZX5	\$7,144.63
48" x .187 x 1	4818EVWZX5	\$6,831.53
48" x .210 x 1	4821EVWZX5	\$7,192.03
48" x .250 x 1	4825EVWZX5	\$8,427.60
54" x .187 x 1	5418EVWZX5	\$8,832.35
54" x .210 x 1	5421EVWZX5	\$9,663.30
60" x .210 x 1	6021EVWZX5	\$11,324.01

## V2 SERIES

SIZE	PART #	LIST PRICE
12" x .125 x 1	1212EVRWZX4	\$721.25
12" x .155 x 1	1215EVRWZX4	\$901.86
12" x .187 x 1	1218EVRWZX4	\$1,004.11
12" x .250 x 1	1225EVRWZX4	\$1,251.89
14" x .125 x 1	1412EVRWZX4	\$844.52
14" x .140 x 1	1414EVRWZX4	\$889.58
14" x .155 x 1	1415EVRWZX4	\$1,007.30
14" x .165 x 1	1416EVRWZX4	\$1,059.59
14" x .187 x 1	1418EVRWZX4	\$1,115.85
14" x .250 x 1	1425EVRWZX4	\$1,404.17
16" x .125 x 1	1612EVRWZX4	\$1,014.69
16" x .140 x 1	1614EVRWZX4	\$1,067.75
16" x .155 x 1	1615EVRWZX4	\$1,202.29
16" x .187 x 1	1618EVRWZX4	\$1,368.85
16" x .250 x 1	1625EVRWZX4	\$1,654.14
18" x .125 x 1	1812EVRWZX4	\$1,158.89
18" x .140 x 1	1814EVRWZX4	\$1,240.87
18" x .155 x 1	1815EVRWZX4	\$1,426.95
18" x .165 x 1	1816EVRWZX4	\$1,404.67
18" x .187 x 1	1818EVRWZX4	\$1,526.58
18" x .210 x 1	1821EVRWZX4	\$1,743.26
20" x .125 x 1	2012EVRWZX4	\$1,401.73
20" x .140 x 1	2014EVRWZX4	\$1,482.36
20" x .155 x 1	2015EVRWZX4	\$1,669.77
20" x .165 x 1	2016EVRWZX4	\$1,791.03
20" x .187 x 1	2018EVRWZX4	\$1,867.45
24" x .125 x 1	2412EVRWZX4	\$1,676.00
24" x .140 x 1	2414EVRWZX4	\$1,774.88
24" x .155 x 1	2415EVRWZX4	\$1,989.37
24" x .165 x 1	2416EVRWZX4	\$2,067.82
24" x .187 x 1	2418EVRWZX4	\$2,185.54
24" x .210 x 1	2421EVRWZX4	\$2,499.49
24" x .250 x 1	2425EVRWZX4	\$2,778.98
26" x .155 x 1	2615EVRWZX4	\$2,302.92
26" x .165 x 1	2616EVRWZX4	\$2,473.01
26" x .187 x 1	2618EVRWZX4	\$2,653.53
28" x .175 x 1	2817EVRWZX4	\$2,774.70
30" x .155 x 1	3015EVRWZX4	\$2,749.21
30" x .165 x 1	3016EVRWZX4	\$2,960.52
30" x .175 x 1	3017EVRWZX4	\$2,941.68
30" x .187 x 1	3018EVRWZX4	\$3,164.24
30" x .210 x 1	3021EVRWZX4	\$3,384.37
30" x .250 x 1	3025EVRWZX4	\$3,887.93
36" x .155 x 1	3615EVRWZX4	\$3,458.53
36" x .165 x 1	3616EVRWZX4	\$3,576.24
36" x .175 x 1	3617EVRWZX4	\$3,718.18
36" x .187 x 1	3618EVRWZX4	\$4,052.06
36" x .210 x 1	3621EVRWZX4	\$4,405.21
36" x .250 x 1	3625EVRWZX4	\$4,857.48
42" x .187 x 1	4218EVRWZX4	\$5,215.84
42" x .210 x 1	4221EVRWZX4	\$5,269.06
42" x .250 x 1	4225EVRWZX4	\$5,655.83
48" x .187 x 1	4818EVRWZX4	\$5,892.10
48" x .210 x 1	4821EVRWZX4	\$6,346.15
48" x .250 x 1	4825EVRWZX4	\$7,172.92
54" x .187 x 1	5418EVRWZX4	\$7,524.38
54" x .210 x 1	5421EVRWZX4	\$8,367.05
60" x .210 x 1	6021EVRWZX4	\$9,783.40



### BOND SELECTION CHART (ASPHALT)

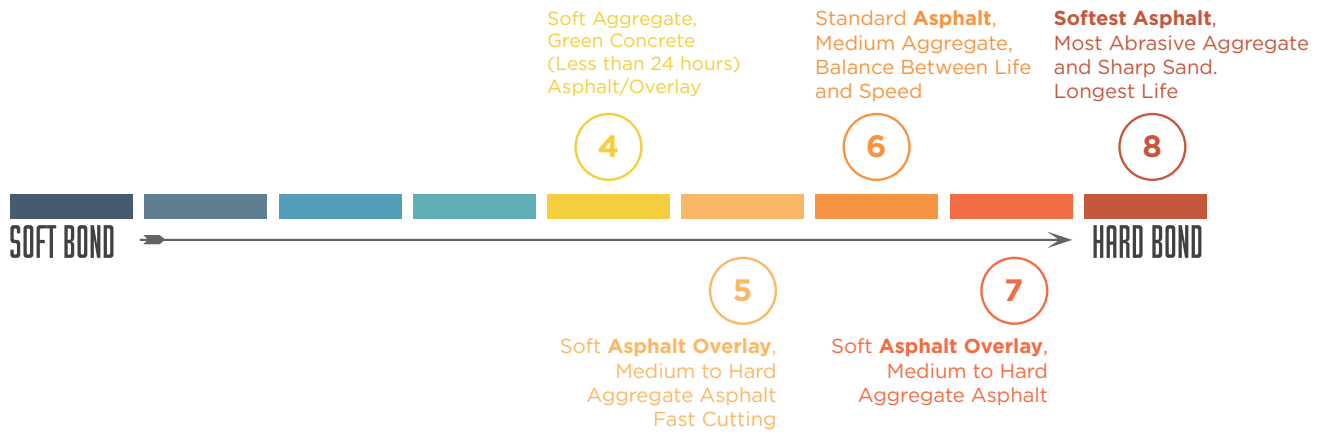

**X1000**  
asphalt

**STANDARD BLADE**

- 10mm (.394") segment height
- Most economical version of our professional series asphalt blades (not for machines over 65HP)



**X2000**  
asphalt

**HEAVY DUTY BLADE**

- 10mm (.394") segment height
- Balance between cost and performance (not for machines over 65HP)



**X4000**  
asphalt

**SUPREME BLADE**

- 10mm (.394") segment height
- Utilizes our highest quality diamond for maximum performance in cutting asphalt
- Highly recommended for machines 65HP and larger
- Offers user the lowest cost per cut



**X1000**

SIZE	PART #	LIST PRICE
12" x .125 x 1	1212EWAX1	\$570.21
12" x .155 x 1	1215EWAX1	\$645.71
12" x .187 x 1	1218EWAX1	\$726.25
12" x .250 x 1	1225EWAX1	\$908.87
12" x .375 x 1	1237EWAX1	\$1,008.99
12" x .500 x 1	1250EWAX1	\$1,673.24
14" x .125 x 1	1412EWAX1	\$656.93
14" x .140 x 1	1414EWAX1	\$706.79
14" x .155 x 1	1415EWAX1	\$762.41
14" x .165 x 1	1416EWAX1	\$833.17
14" x .187 x 1	1418EWAX1	\$847.07
14" x .250 x 1	1425EWAX1	\$1,039.89
14" x .310 x 1	1431EWAX1	\$1,193.98
14" x .375 x 1	1437EWAX1	\$1,255.06
14" x .500 x 1	1450EWAX1	\$1,807.75
16" x .125 x 1	1612EWAX1	\$767.45
16" x .140 x 1	1614EWAX1	\$828.33
16" x .155 x 1	1615EWAX1	\$885.08
16" x .187 x 1	1618EWAX1	\$996.22
16" x .250 x 1	1625EWAX1	\$1,186.77
16" x .375 x 1	1637EWAX1	\$1,472.49
18" x .125 x 1	1812EWAX1	\$898.88
18" x .140 x 1	1814EWAX1	\$973.45
18" x .155 x 1	1815EWAX1	\$1,037.31
18" x .165 x 1	1816EWAX1	\$1,088.50
18" x .187 x 1	1818EWAX1	\$1,173.58
18" x .210 x 1	1821EWAX1	\$1,281.32
18" x .250 x 1	1825EWAX1	\$1,403.99
18" x .375 x 1	1837EWAX1	\$1,675.19
20" x .125 x 1	2012EWAX1	\$1,020.73
20" x .140 x 1	2014EWAX1	\$1,105.09
20" x .155 x 1	2015EWAX1	\$1,202.83
20" x .165 x 1	2016EWAX1	\$1,242.80
20" x .187 x 1	2018EWAX1	\$1,359.19
20" x .375 x 1	2037EWAX1	\$2,126.33
24" x .125 x 1	2412EWAX1	\$1,287.91
24" x .140 x 1	2414EWAX1	\$1,377.93
24" x .155 x 1	2415EWAX1	\$1,515.03
24" x .165 x 1	2416EWAX1	\$1,543.76
24" x .187 x 1	2418EWAX1	\$1,682.51
24" x .210 x 1	2421EWAX1	\$1,850.40
24" x .250 x 1	2425EWAX1	\$1,920.85
26" x .155 x 1	2615EWAX1	\$1,927.44
26" x .165 x 1	2616EWAX1	\$1,958.24
26" x .187 x 1	2618EWAX1	\$2,101.41
30" x .155 x 1	3015EWAX1	\$2,332.44
30" x .165 x 1	3016EWAX1	\$2,367.25
30" x .175 x 1	3017EWAX1	\$2,493.94
30" x .187 x 1	3018EWAX1	\$2,528.75
30" x .210 x 1	3021EWAX1	\$2,730.84
30" x .250 x 1	3025EWAX1	\$2,834.87
36" x .175 x 1	3617EWAX1	\$3,177.86
36" x .187 x 1	3618EWAX1	\$3,220.91
36" x .210 x 1	3621EWAX1	\$3,539.18
36" x .250 x 1	3625EWAX1	\$3,630.44
42" x .187 x 1	4218EWAX1	\$4,227.74
42" x .210 x 1	4221EWAX1	\$4,591.74
42" x .250 x 1	4225EWAX1	\$4,638.91
48" x .187 x 1	4818EWAX1	\$4,755.20
48" x .210 x 1	4821EWAX1	\$5,257.84
48" x .250 x 1	4825EWAX1	\$5,397.10
54" x .187 x 1	5418EWAX1	\$6,151.68
54" x .210 x 1	5421EWAX1	\$6,750.72
60" x .210 x 1	6021EWAX1	\$7,782.27
60" x .250 x 1	6025EWAX1	\$10,047.75

**X2000**

SIZE	PART #	LIST PRICE
12" x .125 x 1	1212EWAX2	\$641.18
12" x .155 x 1	1215EWAX2	\$743.76
12" x .187 x 1	1218EWAX2	\$857.37
12" x .250 x 1	1225EWAX2	\$939.15
12" x .375 x 1	1237EWAX2	\$1,060.28
12" x .500 x 1	1250EWAX2	\$1,849.78
14" x .125 x 1	1412EWAX2	\$735.32
14" x .140 x 1	1414EWAX2	\$812.77
14" x .155 x 1	1415EWAX2	\$876.84
14" x .165 x 1	1416EWAX2	\$898.16
14" x .187 x 1	1418EWAX2	\$1,000.03
14" x .250 x 1	1425EWAX2	\$1,075.22
14" x .310 x 1	1431EWAX2	\$1,471.46
14" x .375 x 1	1437EWAX2	\$1,505.04
14" x .500 x 1	1450EWAX2	\$1,975.95
16" x .125 x 1	1612EWAX2	\$856.96
16" x .140 x 1	1614EWAX2	\$949.45
16" x .155 x 1	1615EWAX2	\$1,015.89
16" x .187 x 1	1618EWAX2	\$1,171.11
16" x .250 x 1	1625EWAX2	\$1,227.14
18" x .125 x 1	1812EWAX2	\$999.51
18" x .140 x 1	1814EWAX2	\$1,109.62
18" x .155 x 1	1815EWAX2	\$1,184.40
18" x .165 x 1	1816EWAX2	\$1,226.11
18" x .187 x 1	1818EWAX2	\$1,370.31
18" x .210 x 1	1821EWAX2	\$1,383.81
18" x .250 x 1	1825EWAX2	\$1,449.42
20" x .125 x 1	2012EWAX2	\$1,185.43
20" x .140 x 1	2014EWAX2	\$1,313.15
20" x .155 x 1	2015EWAX2	\$1,433.55
20" x .165 x 1	2016EWAX2	\$1,479.90
20" x .187 x 1	2018EWAX2	\$1,615.25
24" x .125 x 1	2412EWAX2	\$1,457.35
24" x .140 x 1	2414EWAX2	\$1,585.38
24" x .155 x 1	2415EWAX2	\$1,718.14
24" x .165 x 1	2416EWAX2	\$1,760.89
24" x .187 x 1	2418EWAX2	\$1,941.45
24" x .210 x 1	2421EWAX2	\$1,879.03
24" x .250 x 1	2425EWAX2	\$2,064.33
26" x .155 x 1	2615EWAX2	\$2,145.08
26" x .165 x 1	2616EWAX2	\$2,190.71
26" x .187 x 1	2618EWAX2	\$2,378.89
30" x .155 x 1	3015EWAX2	\$2,578.91
30" x .165 x 1	3016EWAX2	\$2,630.72
30" x .175 x 1	3017EWAX2	\$2,768.23
30" x .187 x 1	3018EWAX2	\$2,843.21
30" x .210 x 1	3021EWAX2	\$2,765.65
30" x .250 x 1	3025EWAX2	\$3,009.15
36" x .175 x 1	3617EWAX2	\$3,516.73
36" x .187 x 1	3618EWAX2	\$3,609.33
36" x .210 x 1	3621EWAX2	\$3,582.24
36" x .250 x 1	3625EWAX2	\$3,845.61
42" x .187 x 1	4218EWAX2	\$4,653.13
42" x .210 x 1	4221EWAX2	\$4,638.91
42" x .250 x 1	4225EWAX2	\$4,918.66
48" x .187 x 1	4818EWAX2	\$5,254.65
48" x .210 x 1	4821EWAX2	\$5,313.15
48" x .250 x 1	4825EWAX2	\$5,673.76
54" x .187 x 1	5418EWAX2	\$6,706.64
54" x .210 x 1	5421EWAX2	\$6,812.21
60" x .210 x 1	6021EWAX2	\$7,849.84
60" x .250 x 1	6025EWAX2	\$10,300.00

**X4000**

SIZE	PART #	LIST PRICE
12" x .125 x 1	1212EWAX4	\$722.26
12" x .155 x 1	1215EWAX4	\$835.52
12" x .187 x 1	1218EWAX4	\$963.83
12" x .250 x 1	1225EWAX4	\$1,077.17
12" x .375 x 1	1237EWAX4	\$1,723.67
12" x .500 x 1	1250EWAX4	\$2,060.00
14" x .125 x 1	1412EWAX4	\$828.46
14" x .140 x 1	1414EWAX4	\$916.07
14" x .155 x 1	1415EWAX4	\$984.93
14" x .165 x 1	1416EWAX4	\$1,020.83
14" x .187 x 1	1418EWAX4	\$1,124.26
14" x .250 x 1	1425EWAX4	\$1,271.23
14" x .310 x 1	1431EWAX4	\$1,807.75
14" x .375 x 1	1437EWAX4	\$2,017.96
14" x .500 x 1	1450EWAX4	\$2,429.96
16" x .125 x 1	1612EWAX4	\$965.25
16" x .140 x 1	1614EWAX4	\$1,069.85
16" x .155 x 1	1615EWAX4	\$1,140.90
16" x .187 x 1	1618EWAX4	\$1,316.13
16" x .250 x 1	1625EWAX4	\$1,408.37
18" x .125 x 1	1812EWAX4	\$1,125.35
18" x .140 x 1	1814EWAX4	\$1,249.79
18" x .155 x 1	1815EWAX4	\$1,329.67
18" x .165 x 1	1816EWAX4	\$1,391.81
18" x .187 x 1	1818EWAX4	\$1,539.45
18" x .210 x 1	1821EWAX4	\$1,489.84
18" x .250 x 1	1825EWAX4	\$1,660.86
20" x .125 x 1	2012EWAX4	\$1,339.59
20" x .140 x 1	2014EWAX4	\$1,477.23
20" x .155 x 1	2015EWAX4	\$1,611.08
20" x .165 x 1	2016EWAX4	\$1,662.54
20" x .187 x 1	2018EWAX4	\$1,812.88
24" x .125 x 1	2412EWAX4	\$1,645.43
24" x .140 x 1	2414EWAX4	\$1,782.83
24" x .155 x 1	2415EWAX4	\$1,930.22
24" x .165 x 1	2416EWAX4	\$1,977.70
24" x .187 x 1	2418EWAX4	\$2,178.35
24" x .210 x 1	2421EWAX4	\$2,119.74
24" x .250 x 1	2425EWAX4	\$2,396.19
26" x .155 x 1	2615EWAX4	\$2,406.18
26" x .165 x 1	2616EWAX4	\$2,456.96
26" x .187 x 1	2618EWAX4	\$2,665.95
30" x .155 x 1	3015EWAX4	\$2,891.31
30" x .165 x 1	3016EWAX4	\$2,948.89
30" x .175 x 1	3017EWAX4	\$3,127.39
30" x .187 x 1	3018EWAX4	\$3,184.97
30" x .210 x 1	3021EWAX4	\$3,279.21
30" x .250 x 1	3025EWAX4	\$3,467.91
36" x .175 x 1	3617EWAX4	\$3,971.17
36" x .187 x 1	3618EWAX4	\$4,042.34
36" x .210 x 1	3621EWAX4	\$3,978.99
36" x .250 x 1	3625EWAX4	\$4,426.63
42" x .187 x 1	4218EWAX4	\$5,205.21
42" x .210 x 1	4221EWAX4	\$5,206.65
42" x .250 x 1	4225EWAX4	\$5,633.69
48" x .187 x 1	4818EWAX4	\$5,879.45
48" x .210 x 1	4821EWAX4	\$5,965.04
48" x .250 x 1	4825EWAX4	\$6,501.88
54" x .187 x 1	5418EWAX4	\$7,497.27
54" x .210 x 1	5421EWAX4	\$7,637.35
60" x .210 x 1	6021EWAX4	\$8,797.23
60" x .250 x 1	6025EWAX4	\$11,729.43

### WALL SAW BLADES PERFORMANCE CHART

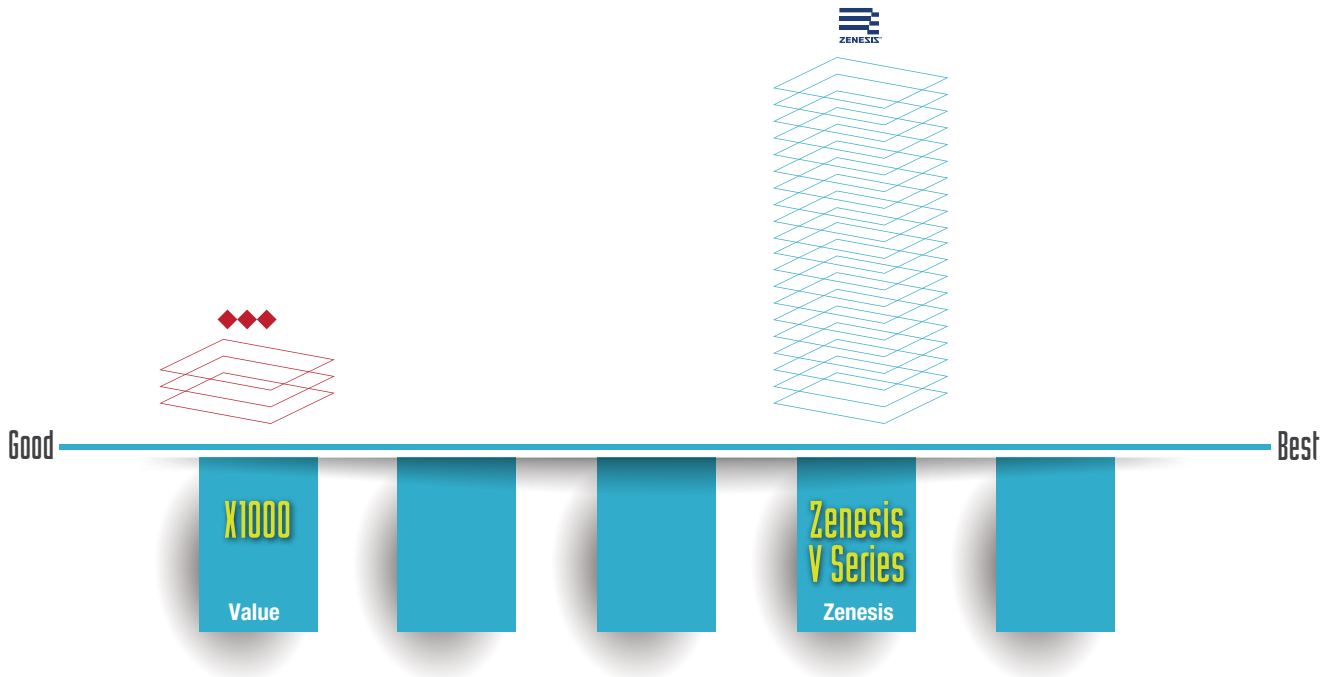

### BOND SELECTION CHART (WALL SAW)

**Critically Hard Concrete,**  
Flint/River Rock  
Aggregate, Heavy Steel  
Reinforcement, Fastest  
Cutting

**Cured Concrete,**  
Medium Aggregate,  
Medium Steel  
Reinforcement, Balance  
Between Life and Speed

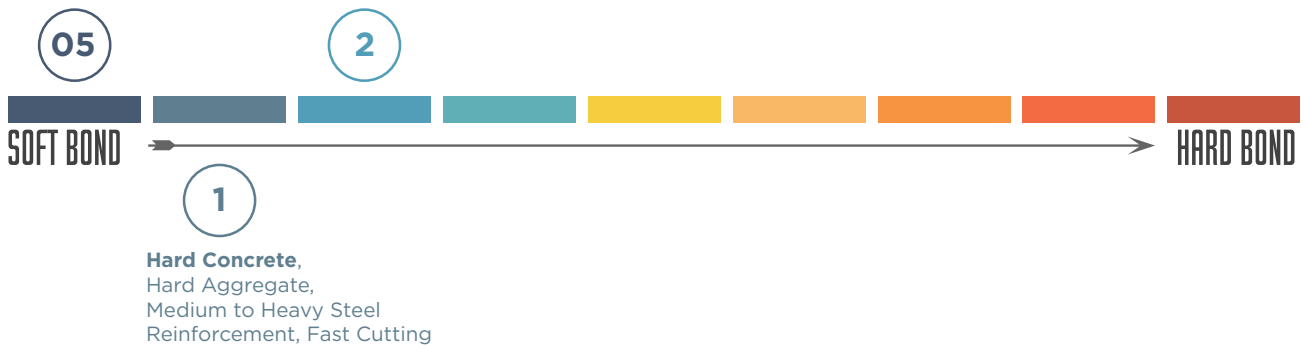



**X1000**  
wall saw

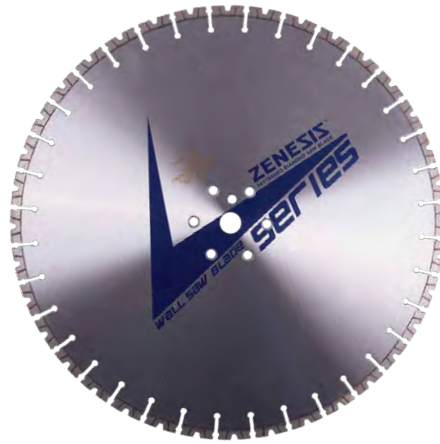

**ZENESIS™ V SERIES**  
wall saw

**STANDARD PLUS BLADE**

- 10mm (.394") segment height
- Our most economical wall saw blade
- For air or hydraulic saws
- Available in 3 bonds



**ZENESIS™ BLADE**

- Features ZENESIS™, the most advanced diamond pattern for fast cutting through hard, reinforced concrete and long blade life.
- All-New 12mm Segments
- Laser welded



SIZE	PART #	LIST PRICE
12" x .125 x 1	1212EWWWX1-1SP	\$440.12
12" x .155 x 1	1215EWWWX1-1SP	\$469.47
12" x .187 x 1	1218EWWWX1-1SP	\$512.32
12" x .250 x 1	1225EWWWX1-1SP	\$585.04
12" x .375 x 1	1237EWWWX1-1SP	\$632.01
12" x .500 x 1	1250EWWWX1-1SP	\$1,084.69
14" x .125 x 1	1412EWWWX1-1SP	\$505.01
14" x .140 x 1	1414EWWWX1-1SP	\$539.10
14" x .155 x 1	1415EWWWX1-1SP	\$561.04
14" x .165 x 1	1416EWWWX1-1SP	\$568.05
14" x .187 x 1	1418EWWWX1-1SP	\$601.73
14" x .250 x 1	1425EWWWX1-1SP	\$695.66
14" x .500 x 1	1450EWWWX1-1SP	\$1,193.98
16" x .125 x 1	1612EWWWX1-1SP	\$597.30
16" x .140 x 1	1614EWWWX1-1SP	\$640.35
16" x .155 x 1	1615EWWWX1-1SP	\$658.48
16" x .187 x 1	1618EWWWX1-1SP	\$719.35
16" x .250 x 1	1625EWWWX1-1SP	\$797.01
18" x .125 x 1	1812EWWWX1-1SP	\$702.25
18" x .140 x 1	1814EWWWX1-1SP	\$756.64
18" x .155 x 1	1815EWWWX1-1SP	\$777.03
18" x .165 x 1	1816EWWWX1-1SP	\$800.52
18" x .187 x 1	1818EWWWX1-1SP	\$856.96
18" x .210 x 1	1821EWWWX1-1SP	\$892.60
18" x .250 x 1	1825EWWWX1-1SP	\$960.17
20" x .125 x 1	2012EWWWX1-1SP	\$844.19
20" x .140 x 1	2014EWWWX1-1SP	\$895.89
20" x .155 x 1	2015EWWWX1-1SP	\$939.15
20" x .165 x 1	2016EWWWX1-1SP	\$960.99
20" x .187 x 1	2018EWWWX1-1SP	\$1,019.80

SIZE	PART #	LIST PRICE
24" x .125 x 1	2412EWWWX1-1SP	\$1,078.82
24" x .140 x 1	2414EWWWX1-1SP	\$1,133.62
24" x .155 x 1	2415EWWWX1-1SP	\$1,176.26
24" x .165 x 1	2416EWWWX1-1SP	\$1,190.47
24" x .187 x 1	2418EWWWX1-1SP	\$1,281.94
24" x .210 x 1	2421EWWWX1-1SP	\$1,358.47
24" x .250 x 1	2425EWWWX1-1SP	\$1,467.34
26" x .155 x 1	2615EWWWX1-1SP	\$1,474.34
26" x .165 x 1	2616EWWWX1-1SP	\$1,489.48
26" x .187 x 1	2618EWWWX1-1SP	\$1,582.08
30" x .155 x 1	3015EWWWX1-1SP	\$1,818.88
30" x .165 x 1	3016EWWWX1-1SP	\$1,835.98
30" x .175 x 1	3017EWWWX1-1SP	\$1,914.56
30" x .187 x 1	3018EWWWX1-1SP	\$1,940.31
30" x .210 x 1	3021EWWWX1-1SP	\$2,031.37
30" x .250 x 1	3025EWWWX1-1SP	\$2,182.06
36" x .175 x 1	3617EWWWX1-1SP	\$2,493.84
36" x .187 x 1	3618EWWWX1-1SP	\$2,613.73
36" x .210 x 1	3621EWWWX1-1SP	\$2,746.91
36" x .250 x 1	3625EWWWX1-1SP	\$2,930.04
42" x .187 x 1	4218EWWWX1-1SP	\$3,685.65
42" x .210 x 1	4221EWWWX1-1SP	\$3,833.15
42" x .250 x 1	4225EWWWX1-1SP	\$4,049.34
48" x .187 x 1	4818EWWWX1-1SP	\$4,056.45
48" x .210 x 1	4821EWWWX1-1SP	\$4,313.54
48" x .250 x 1	4825EWWWX1-1SP	\$4,585.66
54" x .187 x 1	5418EWWWX1-1SP	\$5,407.09
54" x .210 x 1	5421EWWWX1-1SP	\$5,808.89
60" x .210 x 1	6021EWWWX1-1SP	\$6,775.75
60" x .250 x 1	6025EWWWX1-1SP	\$6,951.47

SIZE	PART #	LIST PRICE
20" x .125 x 1	2012EWWWZX4	\$1,308.76
20" x .140 x 1	2014EWWWZX4	\$1,305.59
20" x .155 x 1	2015EWWWZX4	\$1,368.63
20" x .165 x 1	2016EWWWZX4	\$1,400.45
20" x .187 x 1	2018EWWWZX4	\$1,486.16
24" x .125 x 1	2412EWWWZX4	\$1,572.17
24" x .140 x 1	2414EWWWZX4	\$1,652.03
24" x .155 x 1	2415EWWWZX4	\$1,714.17
24" x .165 x 1	2416EWWWZX4	\$1,734.88
24" x .187 x 1	2418EWWWZX4	\$1,868.17
24" x .210 x 1	2421EWWWZX4	\$1,979.69
24" x .250 x 1	2425EWWWZX4	\$2,138.35
26" x .155 x 1	2615EWWWZX4	\$2,157.56
26" x .165 x 1	2616EWWWZX4	\$2,170.62
26" x .187 x 1	2618EWWWZX4	\$2,305.56
30" x .155 x 1	3015EWWWZX4	\$2,650.65
30" x .165 x 1	3016EWWWZX4	\$2,675.57
30" x .175 x 1	3017EWWWZX4	\$2,790.09
30" x .187 x 1	3018EWWWZX4	\$2,827.62
30" x .210 x 1	3021EWWWZX4	\$2,960.31
30" x .250 x 1	3025EWWWZX4	\$3,179.91
36" x .175 x 1	3617EWWWZX4	\$3,634.27
36" x .187 x 1	3618EWWWZX4	\$3,808.99
36" x .210 x 1	3621EWWWZX4	\$4,003.07
36" x .250 x 1	3625EWWWZX4	\$4,119.85
42" x .187 x 1	4218EWWWZX4	\$5,371.10
42" x .210 x 1	4221EWWWZX4	\$5,586.05
42" x .250 x 1	4225EWWWZX4	\$5,901.11
48" x .187 x 1	4818EWWWZX4	\$5,911.47
48" x .210 x 1	4821EWWWZX4	\$6,286.12
48" x .250 x 1	4825EWWWZX4	\$6,682.69
54" x .187 x 1	5418EWWWZX4	\$7,879.76
54" x .210 x 1	5421EWWWZX4	\$8,465.30
60" x .210 x 1	6021EWWWZX4	\$9,874.31
60" x .250 x 1	6025EWWWZX4	\$10,130.38

**ACR**  
[duty grade]  
w/Rebar, Concrete,  
Steel, Ductile  
Iron, PVC

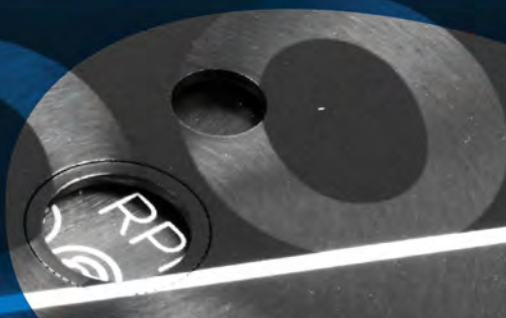

**14"**  
MAX RPM: 5,460

**diamondvantage.com**  
866-322-4078

# SPECIALTY PRODUCTS



**PAVEMENT GRINDING**

Diamond Vantage offers blades for removing layers of concrete or asphalt. These blades are stacked together with spacers between the blades. This offers incredibly efficient removal of any unwanted pavement.

Grinding can solve many irregularities in the pavement, including:

- Faulting at joints or cracks
- Roughness
- Wheel ruts in older concrete
- High noise levels
- Warping caused by moisture

Our grinding blades are available with ZENESIS™ Technology 2.0, the world's most advanced pattern technology, which ensures smooth consistent grinds and long blade life.

Call for Pricing!



**DIAMOND WIRE**

**PREMIUM WIRE**

- Available for wet or dry sawing
- 10.5 & 11mm bead sizes



BEADS /METER	BEAD SIZE	PART #	List Price (per Meter)
40	10.5mm	40105WSCX2-1	\$591.12
Critically Hard Concrete / Regular Type			
40	10.5mm	40105WSCX2	\$529.73
Concrete / Regular Type			
40	10.5mm	40105WSCEW	\$412.00
Concrete / Electroplated Type			
40	10.5mm	40105WSCED	\$504.49
Concrete / Electroplated Type / Dry			
48	11mm	48110WSCBSL	\$521.28
Concrete, w/heavy steel / Brazed Single Layer (BSL) Type			
36	11mm	36110WSGX2	\$369.98
Granite (class 3-4) / Regular Type			
48	10.5mm	48105WSSEW	\$588.54
Steel / Electroplated Type			



**X100 wire brush**

**SUPREME BLADE**

- Designed to use on low horsepower flat saws (5 to 20 hp)
- Oil tempered crimped steel wire with a 3/8" face width
- Low fill density wire brush offers great flexibility, providing efficient cleaning
- High fill density wire brush is good for finer finishes and fast cleaning
- Max. RPM : 4,500 rpm for 12" wire brush

**Application(s)**

- For joint or crack cleaning in concrete or asphalt



SIZE	PART #	LIST PRICE
8" x 3/8" x 7/8-5/8"	0837CDWBX1	\$ 48.80
12" x 3/8" x 1" w/PH, Low Fill Density	1237EDWBX1	\$97.60
12" x 3/8" x 1" w/PH, High Fill Density	1237EDWBX2	\$104.10



**X200**  
ring saw



**HEAVY DUTY BLADE**

- 8mm (.315") segment height
- Offers 10" depth of cut
- Includes free drive wheel

Available in various sizes and bonds based on

**Application(s)**

- 1 bond - old, hard concrete
- 2 bond - cured concrete
- 3 bond - abrasive materials



SIZE	PART #	LIST PRICE
14 x .165 x Drive (1 bond)	1416RDUX2-1	\$413.44
14 x .165 x Drive (2 bond)	1416RDUX2-2	\$413.44
14 x .235 x Drive (2 bond)	1423RDUX2-2	\$457.42
14 x .165 x Drive (3 bond)	1416RDUX2-3	\$439.09



replaces **X2-RING**



**ZENESIS™**  
ring saw



**ZENESIS™ BLADE**

- Exclusive "patterned" technology for maximum performance
- 10mm (.394") segment height
- Offers 10" depth of cut
- Includes free drive wheel

Available in various sizes and bonds based on

**Application(s)**

- 1 bond - old, hard concrete
- 2 bond - cured concrete
- 3 bond - abrasive materials



SIZE	PART #	LIST PRICE
14 x .165 x DRIVE (1 bond)	1416RZX4-1	\$594.62
14 x .165 x DRIVE (2 bond)	1416RZX4	\$594.62
14 x .235 x DRIVE (2 bond)	1423RZX4	\$713.58
14 x .165 x DRIVE (3 bond)	1416RZX4-3	\$594.62



replaces **ZX4 RING**



**DRIVE WHEEL**

- Free with purchase of any ring saw blade (also sold separately)



SIZE	PART #	LIST PRICE
DRIVE WHEEL	DW	\$42.02



**X200-AC\***  
all cut



**X200-ACR\***  
all cut rescue



**X400\***  
ductile iron

**HEAVY DUTY BLADE**

- 5mm (.196") segment height
- Designed to cut the widest range of applications...at a moment's notice

**Application(s)**

- Cured Concrete, W/Rebar, Angle Iron, Steel, Ductile Iron, PVC ...and much more



SIZE	PART #	LIST PRICE
3 x .090 x 3/8	0309TDUX2-AC2	\$46.25
4 x .110 x 7/8-5/8	0411CDUX2-AC2	\$56.34
4.5 x .110 X 7/8-5/8	4511CDUX2-AC2	\$59.74
5 x .110 x 7/8-5/8	0511CDUX2-AC2	\$67.26
6 x .125 x U/A	0612UDUX2-AC2	\$92.49
7 x .125 x U/A	0712UDUX2-AC2	\$106.19
8 x .125 x U/A	0812UDUX2-AC2	\$142.96
9 x .125 x U/A	0912UDUX2-AC2	\$163.98
10 x .125 x U/A	1012UDUX2-AC2	\$193.43
12 x .142 x 20mm	1214BDUX2-AC2	\$248.33
12 x .142 x 1/20mm	1214BEDUX2-AC2	\$248.33
14 x .142 x 20mm	1414BDUX2-AC2	\$285.10
14 x .142 x 1/20mm	1414BEDUX2-AC2	\$285.10
16 x .145 x 1/20mm	1614BEDUX2-AC2	\$367.81
18 x .145 x 1	1814EDUX2-AC2	\$551.77
20 x .155 x 1	2015EDUX2-AC2	\$655.80



replaces **X2-AC2\***

**HEAVY DUTY BLADE**

- 5mm (.196") segment height
- Designed to cut the widest range of applications...at a moment's notice
- With side plating

**Application(s)**

- Cured Concrete, W/Rebar, Angle Iron, Steel, Ductile Iron, PVC ...and much more



SIZE	PART #	LIST PRICE
12 x .142 x 20mm	1214BDUX2-ACR2	\$302.72
12 x .145 x 1/20mm	1214BEDUX2-ACR2	\$302.72
14 x .142 x 20mm	1414BDUX2-ACR2	\$369.98
14 x .145 x 1/20mm	1414BEDUX2-ACR2	\$369.98
16 x .145 x 1/20mm	1614BEDUX2-ACR2	\$504.49



replaces **X2-ACR2\***

**SUPREME BLADE**

- 5mm (.196") segment height
- Side plating for added protection through the cut

**Application(s)**

- Ductile Iron, Concrete Pipe



SIZE	PART #	LIST PRICE
12 x .110 x 1/20mm	1211BEDDIX4-4	\$285.41
12 x .125 x 1/20mm	1212BEDDIX4-4	\$323.83
14 x .110 x 1/20mm	1411BEDDIX4-4	\$332.07
14 x .125 x 1/20mm	1412BEDDIX4-4	\$408.91
16 x .125 x 1/20mm	1612BEDDIX4-4	\$449.18



replaces **X4-4\***

**24** | \* While the blade can be used to occasionally cut steel, it was not designed for heavy steel cutting applications. For demanding metal-working applications, please refer to DiamondX® (p139) products. While adapters permit any blade to be used on various manufacturers' saws, certain manufacturers recommend against using particular type of blades on their machines. As such, customers are requested to check suitability of all blades before purchase and use on any given saw and/or machinery.  
\* CERTAIN MANUFACTURERS OF POWERED SAWS, INCLUDING STIHL® AND HUSQVARNA®, PROHIBIT USE OF ABRASION SIDE COATED BLADES ON THEIR SAWS.  
STIHL® is a trademark of Andreas Stihl AG & Co. HUSQVARNA® is a trademark of Husqvarna AB





**CORE  
DRILLING**



**X300\***  
hard concrete

**PREMIUM BIT**

- 8mm (.315") segment height
- 14" barrel length

**Application(s)**

- Hard Concrete, Brick, Reinforced Concrete, Concrete Block



SIZE	PART #	LIST PRICE
¾ x .125 x ¾-11	00712HWHX2-1	\$110.59
¾ x .125 x 1 ¼-7	00712JWHX2-1	\$110.59
1 x .125 x ¾-11	01012HWHX2-1	\$120.74
1 x .125 x 1 ¼-7	01012JWHX2-1	\$120.74
1 ⅝ x .125 x ¾-11	01112HWHX2-1	\$125.28
1 ⅝ x .125 x 1 ¼-7	01112JWHX2-1	\$125.28
1 ¼ x .125 x ¾-11	01212HWHX2-1	\$140.72
1 ¼ x .125 x 1 ¼-7	01212JWHX2-1	\$140.72
1 ½ x .125 x ¾-11	01512HWHX2-1	\$150.98
1 ½ x .125 x 1 ¼-7	01512JWHX2-1	\$150.98
1 ¾ x .125 x ¾-11	01712HWHX2-1	\$166.64
1 ¾ x .125 x 1 ¼-7	01712JWHX2-1	\$166.64
2 x .125 x 1 ¼-7	02014JWHX2-1	\$205.85
2 ¼ x .125 x ¾-11	02214JWHX2-1	\$214.81
2 ½ x .155 x 1 ¼-7	02514JWHX2-1	\$223.67
2 ¾ x .155 x 1 ¼-7	02714JWHX2-1	\$256.18
3 x .155 x 1 1/4-7	03014JWHX2-1	\$288.58
3 ¼ x .155 x 1 ¼-7	03214JWHX2-1	\$301.97
3 ½ x .155 x 1 ¼-7	03514JWHX2-1	\$335.56
4 x .155 x 1 ¼-7	04014JWHX2-1	\$357.91
4 ¼ x .155 x 1 ¼-7	04214JWHX2-1	\$369.14
4 ½ x .155 x 1 ¼-7	04514JWHX2-1	\$402.73
5 x .155 x 1 ¼-7	05014JWHX2-1	\$447.44
5 ½ x .155 x 1 ¼-7	05514JWHX2-1	\$492.16
6 x .155 x 1 ¼-7	06014JWHX2-1	\$536.87
6 ¼ x .155 x 1 ¼-7	06214JWHX2-1	\$548.10
6 ½ x .155 x 1 ¼-7	06514JWHX2-1	\$604.04
7 x .155 x 1 ¼-7	07016JWHX2-1	\$637.63
8 x .165 x 1 ¼-7	08016JWHX2-1	\$715.93
9 x .187 x 1 ¼-7	09018JWHX2-1	\$805.36
10 x .187 x 1 ¼-7	10018JWHX2-1	\$906.01
11 x .187 x 1 ¼-7	11018JWHX2-1	\$1,051.49

replaces **X2-1**



**X301 ZZ TURBO\***  
hard concrete

**PREMIUM BIT**

- 8mm (.315") segment height
- ZZ Turbo segment
- 14" barrel length

**Application(s)**

- Hard Concrete, Brick, Reinforced Concrete, Concrete Block



SIZE	PART #	LIST PRICE
1 x .125 x ¾-11	01012HWZGH-1	\$118.04
1 x .125 x 1 ¼-7	01012JWZGH-1	\$118.04
1 ⅝ x .125 x ¾-11	01112HWZGH-1	\$127.33
1 ¼ x .125 x ¾-11	01212HWZGH-1	\$135.43
1 ¼ x .125 x 1 ¼-7	01212JWZGH-1	\$135.43
1 ½ x .125 x ¾-11	01512HWZGH-1	\$144.61
1 ½ x .125 x 1 ¼-7	01512JWZGH-1	\$144.61
1 ¾ x .125 x 1 ¼-7	01712JWZGH-1	\$172.37
2 x .155 x 1 1/4-7	02014JWZGH-1	\$212.87
2 ¼ x .155 x 1 ¼-7	02214JWZGH-1	\$222.16
2 ½ x .155 x 1 ¼-7	02514JWZGH-1	\$231.44
2 ¾ x .155 x 1 ¼-7	02714JWZGH-1	\$265.03
3 x .155 x 1 ¼-7	03014JWZGH-1	\$298.51
3 ¼ x .155 x 1 ¼-7	03214JWZGH-1	\$322.81
3 ½ x .155 x 1 ¼-7	03514JWZGH-1	\$347.11
4 x .155 x 1 ¼-7	04014JWZGH-1	\$370.33
4 ¼ x .155 x 1 ¼-7	04214JWZGH-1	\$381.89
4 ½ x .155 x 1 ¼-7	04514JWZGH-1	\$416.56
5 x .155 x 1 ¼-7	05014JWZGH-1	\$462.89
5 ½ x .155 x 1 ¼-7	05514JWZGH-1	\$509.11
6 x .155 x 1 ¼-7	06014JWZGH-1	\$555.44
6 ¼ x .155 x 1 ¼-7	06214JWZGH-1	\$567.00
6 ½ x .155 x 1 ¼-7	06514JWZGH-1	\$613.33
7 x .165 x 1 ¼-7	07016JWZGH-1	\$659.56
8 x .165 x 1 ¼-7	08016JWZGH-1	\$740.56
9 x .187 x 1 ¼-7	09018JWZGH-1	\$833.11
10 x .187 x 1 ¼-7	10018JWZGH-1	\$937.33
11 x .187 x 1 ¼-7	11018JWZGH-1	\$1,087.67
12 x .87 x 1 ¼-7	12018JWZGH-1	\$1,168.67
14 x .187 x 1 ¼-7	14018JWZGH-1	\$1,874.56

replaces **Z TURBO-1**



**ZENESIS™ SERIES\***  
hard concrete

**ZENESIS™ BIT**

- 10mm (.394") segment height
- Exclusive "pattern" technology for maximum performance
- Fast drilling of cured concrete, with heavy rebar
- 14" barrel length

**Application(s)**

- Hard Concrete, Brick, Reinforced Concrete, Concrete Block



SIZE	PART #	LIST PRICE
2 x .155 x 1 ¼-7	02015JWHZX4-1	\$235.92
2 ½ x .155 x 1 ¼-7	02515JWHZX4-1	\$277.55
3 x .155 x 1 ¼-7	03015JWHZX4-1	\$319.18
3 ½ x .155 x 1 ¼-7	03515JWHZX4-1	\$360.82
4 x .155 x 1 ¼-7	04015JWHZX4-1	\$388.57
4 ¼ x .155 x 1 ¼-7	04215JWHZX4-1	\$418.69
4 ½ x .155 x 1 ¼-7	04515JWHZX4-1	\$455.18
5 x .155 x 1 ¼-7	05015JWHZX4-1	\$492.65
6 x .155 x 1 ¼-7	06015JWHZX4-1	\$555.10
6 ½ x .155 x 1 ¼-7	06515JWHZX4-1	\$599.18
7 x .165 x 1 ¼-7	07016JWHZX4-1	\$673.06
8 x .165 x 1 ¼-7	08016JWHZX4-1	\$981.55
10 x .187 x 1 ¼-7	10018JWHZX4-1	\$1257.14
12 x .187 x 1 ¼-7	12018JWHZX4-1	\$1565.71
14 x .187 x 1 ¼-7	14018JWHZX4-1	\$2142.86

replaces **ZENESIS BLACK**



**ZENESIS™ V SERIES\***  
hard concrete

**ZENESIS™ BIT**

- 10mm (.394") segment height
- Exclusive "pattern" technology for maximum performance
- **Fast drilling** of cured concrete, with heavy rebar
- 14" barrel length

**Application(s)**

- Hard Concrete, Brick, Reinforced Concrete, Concrete Block



SIZE	PART #	LIST PRICE
2 x .155 x 1¼-7	02015JVWHZX4-1	\$235.92
2½ x .155 x 1¼-7	02515JVWHZX4-1	\$277.55
3 x .155 x 1¼-7	03015JVWHZX4-1	\$319.18
3½ x .155 x 1¼-7	03515JVWHZX4-1	\$360.82
4 x .155 x 1¼-7	04015JVWHZX4-1	\$388.57
4¼ x .155 x 1¼-7	04215JVWHZX4-1	\$418.69
4½ x .155 x 1¼-7	04515JVWHZX4-1	\$455.18
5 x .155 x 1¼-7	05015JVWHZX4-1	\$492.65
6 x .155 x 1¼-7	06015JVWHZX4-1	\$555.10
6½ x .155 x 1¼-7	06515JVWHZX4-1	\$599.18
7 x .165 x 1¼-7	07016JVWHZX4-1	\$673.06
8 x .165 x 1¼-7	08016JVWHZX4-1	\$981.55
10 x .187 x 1¼-7	10018JVWHZX4-1	\$1257.14
12 x .187 x 1¼-7	12018JVWHZX4-1	\$1565.71
14 x .187 x 1¼-7	14018JVWHZX4-1	\$2142.86



**X300\***  
concrete

**PREMIUM BIT**

- 8mm (.315") segment height
- Standard style segments for longer life
- 14" barrel length
- Select sizes available in 1 1/4"-7 and 5/8"-11 threading

**Application(s)**

- Concrete



SIZE	PART #	LIST PRICE
¼ x .125 x ¾-11	00712HWHX2	\$110.59
¼ x .125 x 1¼-7	00712JWHX2	\$110.59
⅜ x .125 x 1¼-7	00812JWHX2	\$113.94
1 x .125 x ¾-11	01012HWHX2	\$120.74
1 x .125 x 1¼-7	01012JWHX2	\$120.74
1½ x .125 x ¾-11	01112HWHX2	\$125.28
1½ x .125 x 1¼-7	01112JWHX2	\$125.28
1¼ x .125 x ¾-11	01212HWHX2	\$140.72
1¼ x .125 x 1¼-7	01212JWHX2	\$140.72
1½ x .125 x ¾-11	01512HWHX2	\$150.98
1½ x .125 x 1¼-7	01512JWHX2	\$150.98
1¾ x .125 x ¾-11	01712HWHX2	\$166.64
1¾ x .125 x 1¼-7	01712JWHX2	\$166.64
2 x .155 x 1¼-7	02014JWHX2	\$205.85
2¼ x .155 x 1¼-7	02214JWHX2	\$214.81
2½ x .155 x 1¼-7	02514JWHX2	\$223.67
2¾ x .155 x 1¼-7	02714JWHX2	\$256.18
3 x .155 x 1¼-7	03014JWHX2	\$288.58
3¼ x .155 x 1¼-7	03214JWHX2	\$301.97
3½ x .155 x 1¼-7	03514JWHX2	\$335.56
4 x .155 x 1¼-7	04014JWHX2	\$357.91
4¼ x .155 x 1¼-7	04214JWHX2	\$369.14
4½ x .155 x 1¼-7	04514JWHX2	\$402.73
5 x .155 x 1¼-7	05014JWHX2	\$447.44
5½ x .155 x 1¼-7	05514JWHX2	\$492.16
6 x .155 x 1¼-7	06014JWHX2	\$536.87
6¼ x .155 x 1¼-7	06214JWHX2	\$548.10
6½ x .155 x 1¼-7	06514JWHX2	\$604.04
7 x .165 x 1¼-7	07016JWHX2	\$637.63
8 x .165 x 1¼-7	08016JWHX2	\$715.93
9 x .187 x 1¼-7	09018JWHX2	\$805.36
10 x .187 x 1¼-7	10018JWHX2	\$906.01
11 x .187 x 1¼-7	11018JWHX2	\$1,051.49
12 x .187 x 1¼-7	12018JWHX2	\$1,129.79
14 x .187 x 1¼-7	14018JWHX2	\$1,364.69

replaces **X2**

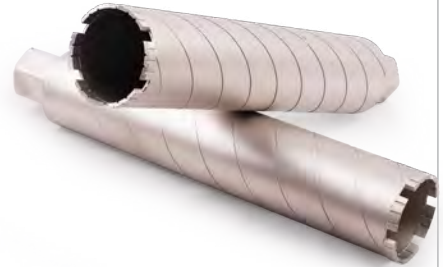

**X301 ZZ TURBO\***  
concrete

**PREMIUM BIT**

- 8mm (.315") segment height
- Unique slanted turbo segment design, w/spiral barrel for fast drilling
- Combination of speed and life
- 14" barrel length
- Select sizes available in 1 1/4"-7 and 5/8"-11 threading

**Application(s)**

- Concrete



SIZE	PART #	LIST PRICE
1 x .125 x ¾-11	01012HWZGH	\$118.04
1 x .125 x 1¼-7	01012JWZGH	\$118.04
1½ x .125 x ¾-11	01112HWZGH	\$127.33
1¼ x .125 x ¾-11	01212HWZGH	\$135.43
1¼ x .125 x 1¼-7	01212JWZGH	\$135.43
1½ x .125 x ¾-11	01512HWZGH	\$144.61
1½ x .125 x 1¼-7	01512JWZGH	\$144.61
1¾ x .125 x 1¼-7	01712JWZGH	\$172.37
2 x .155 x 1¼-7	02014JWZGH	\$212.87
2¼ x .155 x 1¼-7	02214JWZGH	\$222.16
2½ x .155 x 1¼-7	02514JWZGH	\$231.44
2¾ x .155 x 1¼-7	02714JWZGH	\$265.03
3 x .155 x 1¼-7	03014JWZGH	\$298.51
3¼ x .155 x 1¼-7	03214JWZGH	\$322.81
3½ x .155 x 1¼-7	03514JWZGH	\$347.11
4 x .155 x 1¼-7	04014JWZGH	\$370.33
4¼ x .155 x 1¼-7	04214JWZGH	\$381.89
4½ x .155 x 1¼-7	04514JWZGH	\$416.56
5 x .155 x 1¼-7	05014JWZGH	\$462.89
5½ x .155 x 1¼-7	05514JWZGH	\$509.11
6 x .155 x 1¼-7	06014JWZGH	\$555.44
6¼ x .155 x 1¼-7	06214JWZGH	\$567.00
6½ x .155 x 1¼-7	06514JWZGH	\$613.33
7 x .165 x 1¼-7	07016JWZGH	\$659.56
8 x .165 x 1¼-7	08016JWZGH	\$740.56
9 x .187 x 1¼-7	09018JWZGH	\$833.11
10 x .187 x 1¼-7	10018JWZGH	\$937.33
11 x .187 x 1¼-7	11018JWZGH	\$1,087.67
12 x .187 x 1¼-7	12018JWZGH	\$1,168.67
13 x .187 x 1¼-7	13018JWZGH	\$1,874.56
14 x .187 x 1¼-7	14018JWZGH	\$1,411.67

replaces **Z TURBO**



**X302 CROWN**  
general purpose

**PREMIUM BIT**

- 7mm (.276) segment height
- Crown style eliminates segment loss in heavy rebar and wire mesh
- 14" barrel length

**Application(s)**

- Masonry, Brick, Concrete Block



SIZE	PART #	LIST PRICE
½ x .125 x ¾-11	00512HWKH	\$120.96
⅝ x .125 x ¾-11	00612HWKH	\$123.66
¾ x .125 x ¾-11	00712HWKH	\$124.85
⅞ x .125 x ¾-11	00812HWKH	\$126.36
1 x .125 x ¾-11	01012HWKH	\$127.94
1 ⅛ x .125 x ¾-11	01112HWKH	\$137.51
1 ¼ x .125 x ¾-11	01212HWKH	\$145.88
1 ½ x .125 x ¾-11	01212JWKH	\$146.96
1 ⅝ x .125 x ¾-11	01312HWKH	\$155.44
1 ¾ x .125 x ¾-11	01512HWKH	\$167.40
1 ⅞ x .125 x ¾-11	01612HWKH	\$179.36
1 ¾ x .125 x ¾-11	01712HWKH	\$191.31
1 ¾ x .125 x ¾-11	01712JWKH	\$191.31
1 ⅞ x .125 x ¾-11	01812HWKH	\$209.25
2 x .125 x ¾-11	02012HWKH	\$231.97
2 ¼ x .125 x ¾-11	02212HWKH	\$245.12
2 ½ x .125 x ¾-11	02512HWKH	\$257.08

replaces **CROWN**



**X301 ZZ TURBO\***  
pre-stressed concrete

**PREMIUM BIT**

- 8mm (.315") segment height
- For use on pre-stressed concrete
- Close spaced segments for heavy rebar
- 14" barrel length less space between segments eliminates segment loss

**Application(s)**

- Pre-Stressed Concrete, Concrete with rebar



SIZE	PART #	LIST PRICE
1 x .145 x ¾-11	P01014HWZGH	\$169.45
1 ½ x .165 x ¾-11	P01516HWZGH	\$209.84
2 x .165 x 1 ¼-7	P02016JWZGH	\$247.75
2 ½ x .165 x 1 ¼-7	P02516JWZGH	\$269.03
3 x .165 x 1 ¼-7	P03016JWZGH	\$324.11
3 ½ x .165 x 1 ¼-7	P03516JWZGH	\$355.00
4 x .165 x 1 ¼-7	P04016JWZGH	\$445.18
4 ½ x .165 x 1 ¼-7	P04516JWZGH	\$499.61
5 x .165 x 1 ¼-7	P05016JWZGH	\$553.50
5 ½ x .165 x 1 ¼-7	P05516JWZGH	\$597.78
6 x .165 x 1 ¼-7	P06016JWZGH	\$636.88
8 x .165 x 1 ¼-7	P08016JWZGH	\$933.88
9 x .165 x 1 ¼-7	P09016JWZGH	\$1,049.11
10 x .187 x 1 ¼-7	P10018JWZGH	\$1,322.46

replaces **PRE-STRESSED ZZ TURBO**



**X300\***  
asphalt

**PREMIUM BIT**

- 8mm (.315") segment height
- For asphalt and other abrasive materials
- 14" barrel length

**Application(s)**

- Asphalt, Abrasive Concrete



SIZE	PART #	LIST PRICE
2 x .155 x 1 ¼-7	02014JWHAX2	\$205.85
2 ¼ x .155 x 1 ¼-7	02214JWHAX2	\$214.81
2 ½ x .155 x 1 ¼-7	02514JWHAX2	\$223.67
3 x .155 x 1 ¼-7	03014JWHAX2	\$288.58
3 ¼ x .155 x 1 ¼-7	03214JWHAX2	\$312.12
3 ½ x .155 x 1 ¼-7	03514JWHAX2	\$335.56
4 x .155 x 1 ¼-7	04014JWHAX2	\$357.91
4 ¼ x .155 x 1 ¼-7	04214JWHAX2	\$369.14
4 ½ x .155 x 1 ¼-7	04514JWHAX2	\$402.73
5 x .155 x 1 ¼-7	05014JWHAX2	\$447.44
6 x .155 x 1 ¼-7	06014JWHAX2	\$536.87
6 ¼ x .155 x 1 ¼-7	06214JWHAX2	\$548.10
8 x .165 x 1 ¼-7	08016JWHAX2	\$715.93

replaces **X2 ASPHALT**



**X300**  
masonry

**PREMIUM BIT**

- 7mm (.276") segment height
- Standard style segments for balance of life and speed
- For masonry applications
- Not for reinforced concrete
- 10" barrel length
- New barrel design reduces dust released into the air.

**Application(s)**

- Masonry, Brick, Concrete Block



SIZE	PART #	LIST PRICE
1 x .110 x 5/8-11	01011H2DH	\$105.30
1 1/4 x .110 x 5/8-11	01211H2DH	\$113.40
1 1/2 x .110 x 5/8-11	01511H2DH	\$120.31
1 3/4 x .110 x 5/8-11	01711H2DH	\$150.44
2 x .125 x 5/8-11	02012H2DH	\$158.54
2 1/4 x .125 x 5/8-11	02212H2DH	\$165.46
2 1/2 x .125 x 5/8-11	02512H2DH	\$195.59
3 x .125 x 5/8-11	03012H2DH	\$225.61
3 1/2 x .125 x 5/8-11	03512H2DH	\$300.89
4 x .125 x 5/8-11	04012H2DH	\$376.06
4 1/4 x .125 x 5/8-11	04212H2DH	\$399.17
4 1/2 x .125 x 5/8-11	04512H2DH	\$421.20
5 x .125 x 5/8-11	05012H2DH	\$481.36
6 x .125 x 5/8-11	06012H2DH	\$541.51



replaces **STANDARD DRY**



**X301 ZZ TURBO**  
masonry

**PREMIUM BIT**

- 7mm (.276") segment height
- ZZ turbo segments, spiral barrel for faster drilling
- For masonry applications
- Not for reinforced concrete
- 10" barrel length
- New barrel design reduces dust released into the air.

**Application(s)**

- Masonry, Brick, Concrete Block



SIZE	PART #	LIST PRICE
1 x .110 x 5/8-11	01011H2DZGH	\$112.32
1 1/4 x .110 x 5/8-11	01211H2DZGH	\$120.96
1 1/2 x .110 x 5/8-11	01511H2DZGH	\$128.41
1 3/4 x .110 x 5/8-11	01711H2DZGH	\$160.49
2 x .125 x 5/8-11	02012H2DZGH	\$169.13
2 1/4 x .125 x 5/8-11	02212H2DZGH	\$176.47
2 1/2 x .125 x 5/8-11	02512H2DZGH	\$208.55
3 x .125 x 5/8-11	03012H2DZGH	\$240.73
3 1/2 x .125 x 5/8-11	03512H2DZGH	\$320.87
4 x .125 x 5/8-11	04012H2DZGH	\$401.11
4 1/4 x .125 x 5/8-11	04212H2DZGH	\$425.84
4 1/2 x .125 x 5/8-11	04512H2DZGH	\$449.28
5 x .125 x 5/8-11	05012H2DZGH	\$513.43
6 x .125 x 5/8-11	06012H2DZGH	\$577.69



replaces **ZZ TURBO DRY**



**CORE BIT EXTENSIONS**

- Available in various threads and lengths (see below)

SIZE	PART #	LIST PRICE
6" extension, 5/8-11 threads	DVI003	\$149.90
6" extension, 1-1/4-7 threads	DVI004	\$193.97
12" extension, 5/8-11 threads	DVI005	\$193.97
12" extension, 1-1/4-7 threads	DVI006	\$255.64



**CORE BIT  
THREAD ADAPTERS**

- Available in various threads and lengths (see below)

SIZE	PART #	LIST PRICE
1-1/4-7 female to 5/8-11 male	DVI008	\$185.11
5/8-11 female to 1-1/4-7 male	DVI009	\$149.90
5/8-11 male to 1/2" shank	DVI033	\$59.51



## CORE BITS

continuous rim

### PREMIUM BIT

- 5.5mm (.216") segment height
- Sizes over 1" equipped with pilot drill

### Application(s)

- Concrete, Block, Concrete Brick



SIZE	PART #	LIST PRICE
¼ x .080 x 10mm	S-00308SDCRCB	\$78.09
2¼ x .080 x 10mm	S-02208SDCRCB	\$204.35
2½ x .080 x 10mm	S-02508SDCRCB	\$235.16
2¾ x .080 x 10mm	S-02708SDCRCB	\$239.72
2⅞ x .080 x 10mm	S-02808SDCRCB	\$241.50
3 x .080 x 10mm	S-03008SDCRCB	\$243.39
3½ x .080 x 10mm	S-03508SDCRCB	\$322.37
4 x .080 x 10mm	S-04008SDCRCB	\$433.17
4¼ x .080 x 10mm	S-04208SDCRCB	\$444.96
4½ x .080 x 10mm	S-04508SDCRCB	\$517.60

**GENESIS™**

**ZENE**

**EARLY ENTRY**  
GREEN CONCRETE BLADE

# **EARLY ENTRY GREEN CONCRETE**

## THE ZENESIS™ EARLY ENTRY GREEN CONCRETE CUTTING SYSTEM

The ZENESIS Green™ early entry green concrete cutting system features a ninja arbor that easily fits Soff-Cut® saws without adapters.

Color-coded blades maximize life and cutting speed for different aggregate conditions.





## BOND SELECTION CHART

Choose the ZENESIS Green™ early entry bond that matches your aggregate and cutting conditions.

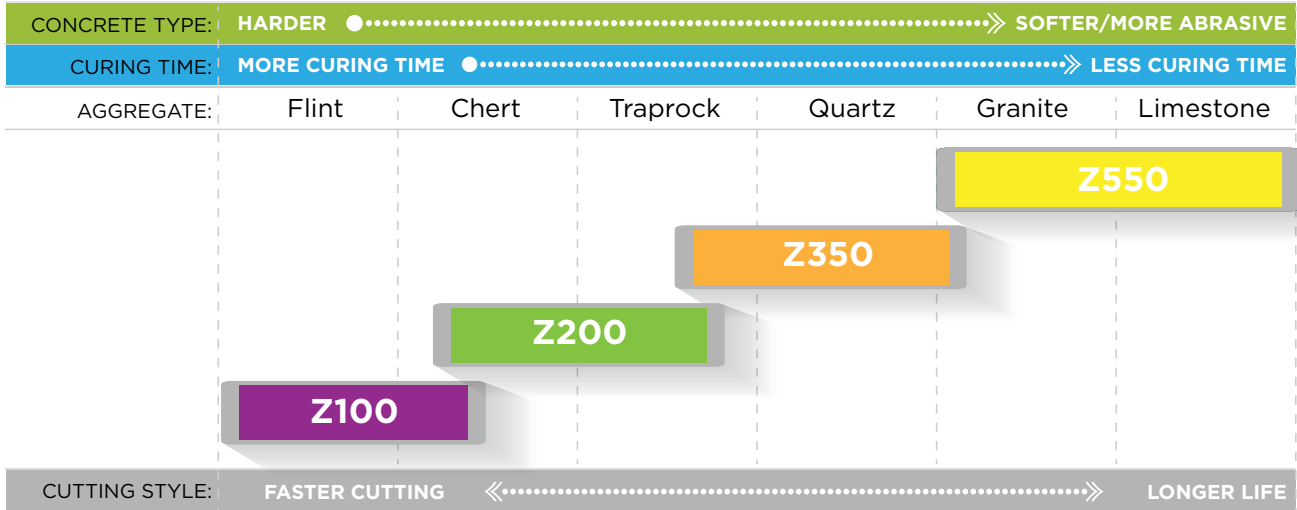

### CROSS REFERENCE

SOFF-CUT®	EZ GREEN
1000 - PURPLE	EZ100(Z)
2000 - GREEN	EZ200(Z)
3000 - RED	EZ350(Z)
4000 - ORANGE	
5000 - YELLOW	EZ550(Z)
6000 - BLACK	

### SAW REFERENCE

MODEL	BLADE SIZE
X-50	5"
X-390	5.5"
X-150	6"
X-450, X-750, GX-1500	8"
X-2000, X-2500	10"
X-4000, GX-4200	12" & 13.5"
X-5000	12" & 14"

\*Soff-Cut® is a registered trademark of Husqvarna AB. Diamond Vantage is not affiliated with Husqvarna AB.  
 \*\*The EZ Green shield: Additional shield sizes available



**Z100 PURPLE**  
green concrete

**ZENESIS™ BLADE**

- 10mm (.394") segment height
- Comparable to Soff-Cut® 1000

**Application(s)**

- Very Hard Aggregate, Flint, Chert

SIZE	PART #	LIST PRICE
5 x .080 x EZ	0508EZ100Z	\$160.96
5½ x .080 x EZ	5508EZ100Z	\$182.00
6 x .095 x EZ	0609EZ100Z	\$233.55
6 x .225 x EZ	0622EZ100Z	\$466.04
8 x .095 x EZ	0809EZ100Z	\$309.30
8 x .225 x EZ	0822EZ100Z	\$635.43
10 x .095 x EZ	1009EZ100Z	\$420.18
10 x .250 x EZ	1025EZ100Z	\$837.41
12 x .125 x EZ	1212EZ100Z	\$607.02
12 x .250 x EZ	1225EZ100Z	\$1,052.03
13½ x .125 x EZ	1312EZ100Z	\$693.28
13½ x .250 x EZ	1325EZ100Z	\$1,157.24
14 x .125 x EZ	1412EZ100Z	\$693.28
14 x .250 x EZ	1425EZ100Z	\$1,157.24



replaces **Z100 PURPLE**



**Z200 GREEN**  
green concrete

**ZENESIS™ BLADE**

- 10mm (.394") segment height
- Comparable to Soff-Cut® 2000

**Application(s)**

- Medium to Hard Chert, Traprock

SIZE	PART #	LIST PRICE
5 x .080 x EZ	0508EZ200Z	\$160.96
5½ x .080 x EZ	5508EZ200Z	\$182.00
6 x .095 x EZ	0609EZ200Z	\$233.55
6 x .225 x EZ	0622EZ200Z	\$466.04
8 x .095 x EZ	0809EZ200Z	\$309.30
8 x .225 x EZ	0822EZ200Z	\$635.43
10 x .095 x EZ	1009EZ200Z	\$420.18
10 x .250 x EZ	1025EZ200Z	\$837.41
12 x .125 x EZ	1212EZ200Z	\$607.02
12 x .250 x EZ	1225EZ200Z	\$1,052.03
13½ x .125 x EZ	1312EZ200Z	\$693.28
13½ x .250 x EZ	1325EZ200Z	\$1,157.24
14 x .125 x EZ	1412EZ200Z	\$693.28
14 x .250 x EZ	1425EZ200Z	\$1,157.24



replaces **Z200 GREEN**



**Z350 ORANGE**  
green concrete

**ZENESIS™ BLADE**

- 10mm (.394") segment height
- Comparable to Soff-Cut® 3000 & 4000

**Application(s)**

- Medium Traprock, Quartz

SIZE	PART #	LIST PRICE
5 x .080 x EZ	0508EZ350Z	\$160.96
5½ x .080 x EZ	5508EZ350Z	\$182.00
6 x .095 x EZ	0609EZ350Z	\$233.55
6 x .225 x EZ	0622EZ350Z	\$466.04
8 x .095 x EZ	0809EZ350Z	\$309.30
8 x .225 x EZ	0822EZ350Z	\$635.43
10 x .095 x EZ	1009EZ350Z	\$420.18
10 x .250 x EZ	1025EZ350Z	\$837.41
12 x .125 x EZ	1212EZ350Z	\$607.02
12 x .250 x EZ	1225EZ350Z	\$1,052.03
13½ x .125 x EZ	1312EZ350Z	\$693.28
13½ x .250 x EZ	1325EZ350Z	\$1,157.24
14 x .125 x EZ	1412EZ350Z	\$693.28
14 x .250 x EZ	1425EZ350Z	\$1,157.24



replaces **Z350 ORANGE**



**Z550 YELLOW**  
green concrete

**ZENESIS™ BLADE**

- 10mm (.394") segment height
- Comparable to Soff-Cut® 5000 & 6000

**Application(s)**

- Soft Granite, Limestone

SIZE	PART #	LIST PRICE
5 x .080 x EZ	0508EZ550Z	\$160.96
5½ x .080 x EZ	5508EZ550Z	\$182.00
6 x .095 x EZ	0609EZ550Z	\$233.55
6 x .225 x EZ	0622EZ550Z	\$466.04
8 x .095 x EZ	0809EZ550Z	\$309.30
8 x .225 x EZ	0822EZ550Z	\$635.43
10 x .095 x EZ	1009EZ550Z	\$420.18
10 x .250 x EZ	1025EZ550Z	\$837.41
12 x .125 x EZ	1212EZ550Z	\$607.02
12 x .250 x EZ	1225EZ550Z	\$1,052.03
13½ x .125 x EZ	1312EZ550Z	\$693.28
13½ x .250 x EZ	1325EZ550Z	\$1,157.24
14 x .125 x EZ	1412EZ550Z	\$693.28
14 x .250 x EZ	1425EZ550Z	\$1,157.24



replaces **Z550 YELLOW**



**X300**  
green concrete

**SUPREME BLADE**

- 12mm (.472") segment height

**Application(s)**

- Very Hard Aggregate, Flint, Chert



SIZE	PART #	LIST PRICE
5 x .080 x 5/8"	0508ADGX3	\$200.13
6 x .095 x 5/8"	0609ADGX3	\$224.64
6 x .095 x 7/8-5/8"	0609CDGX3	\$282.84
7 x .095 x 5/8"	0709ADGX3	\$343.09
7 x .095 x U/A	0709UDGX3	\$343.09
8 x .095 x 5/8"	0809ADGX3	\$378.83
8 x .095 x 7/8-5/8"	0809CDGX3	\$378.83
9 x .095 x 5/8"	0909ADGX3	\$455.36
9 x .095 x 7/8-5/8"	0909CDGX3	\$455.36
10 x .095 x 5/8"	1009ADGX3	\$516.65
10 x .095 x 1/20mm	1009EDGX3	\$516.65

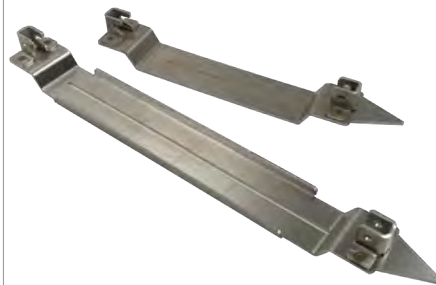

**SKID PLATES**

- Additional sizes available

SIZE	PART #	LIST PRICE
SKID PLATE for 6" & 8" blades	EZPL68	\$144.86
SKID PLATE for 10" blades	EZPL10	\$158.02
SKID PLATE for 12" & 13½ blades	EZPL12	\$164.61
SKID PLATE for 14" blades	EZPL14	\$171.19



replaces **X3 GREEN CONCRETE**

**14"**  
MAX RPM: **5,460**



diamondvantage.com  
866-322-4078

# HIGH SPEED/ MASONRY LOW HP FLAT SAW

### HIGH SPEED/MASONRY GRADE LEVEL CHART



### BOND SELECTION CHART

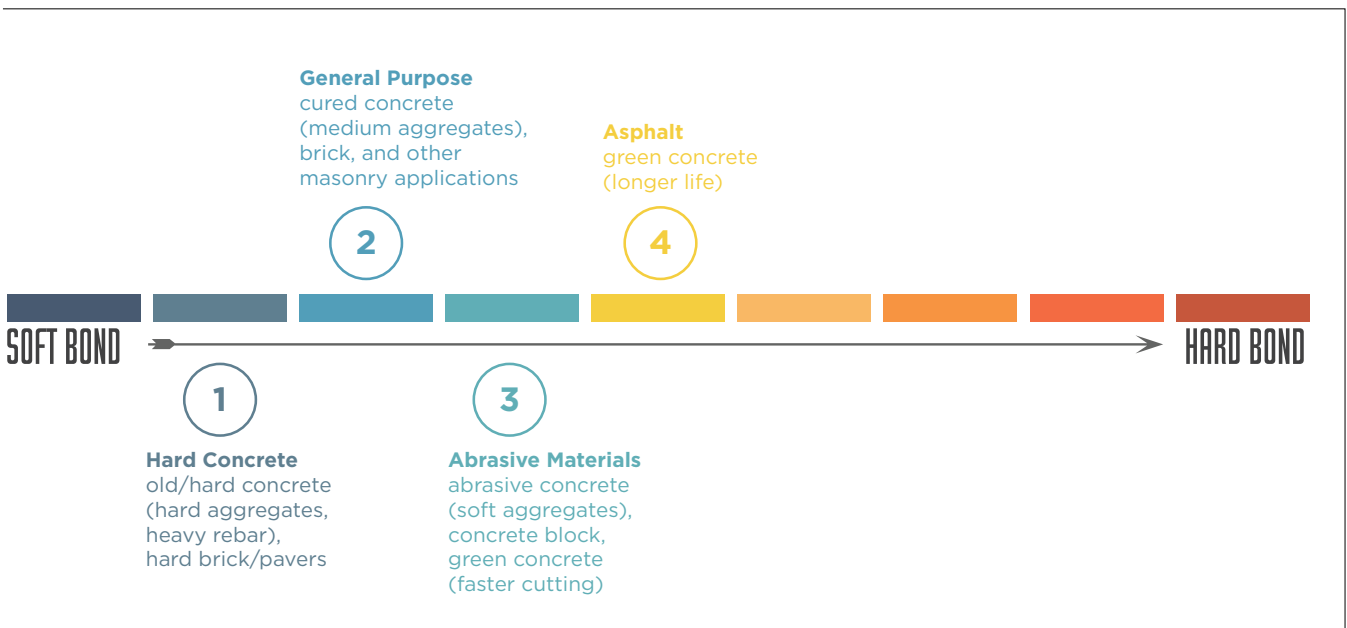



**Y110**  
hard materials



**QUALITY BLADE**

- 12mm (.472") segment height

**Application(s)**

- Old, Hard Concrete, Hard Brick/Pavers, Other Hard Materials



SIZE	PART #	LIST PRICE
12 x .125 x 20mm	1212BY1-1	\$138.84
12 x .125 x 1/20mm	1212EY1-1	\$138.84
14 x .125 x 20mm	1412BY1-1	\$173.56
14 x .125 x 1/20mm	1412EY1-1	\$173.56
16 x .125 x 1/20mm	1612EY1-1	\$286.34



replaces **Y1-1**



**X101 TURBO**  
hard materials



**VALUE BLADE**

- Turbo segments enable faster cutting of old, hard concrete, hard brick/pavers and other hard materials
- Laser welded alternating turbo segments for faster cutting
- Tall .472" (12mm) segments for longer blade life

**Application(s)**

- Old, Hard Concrete, Hard Brick/Pavers, Other Hard Materials



SIZE	PART #	LIST PRICE
14" x .125 x 20mm	1412BLZX1-1	\$191.99
14" x .125 x 1/20mm	1412ELZX1-1	\$191.99



replaces **X1-1**



**X300**  
hard materials



**PREMIUM BLADE**

- 12mm (.472") segment height

**Application(s)**

- Old, Hard Concrete, Hard Brick/Pavers, Other Hard Materials



SIZE	PART #	LIST PRICE
12 x .110 x 1/20mm	1211EX3-1	\$171.50
12 x .125 x 20mm	1212BX3-1	\$182.72
12 x .125 x 1/20mm	1212EX3-1	\$182.72
14 x .110 x 1/20mm	1411EX3-1	\$221.55
14 x .125 x 20mm	1412BX3-1	\$234.84
14 x .125 x 1/20mm	1412EX3-1	\$234.84
16 x .125 x 1/20mm	1612EX3-1	\$408.91
16 x .140 x 1	1614EX3-1	\$430.85
18 x .125 x 1	1812EX3-1	\$508.61
18 x .140 x 1	1814EX3-1	\$533.33
20 x .125 x 1	2012EX3-1	\$588.23
20 x .140 x 1	2014EX3-1	\$615.63
24 x .140 x 1	2414EX3-1	\$818.75
24 x .155 x 1	2415EX3-1	\$895.59



replaces **X3-1**



**X301 TURBO**  
hard materials



**PREMIUM BLADE**

- 12mm (.472") segment height
- Water drop slot, Turbo Segment

**Application(s)**

- Hard Concrete, Reinforced Concrete, Hard Paver Brick, Concrete Pipe, Terrazo



SIZE	PART #	LIST PRICE
12 x .125 x 20mm	1212BZX3-1T	\$182.72
12 x .125 x 1/20mm	1212EZ3-1T	\$182.72
14 x .125 x 20mm	1412BZX3-1T	\$234.84
14 x .125 x 1/20mm	1412EZ3-1T	\$234.84
16 x .125 x 1/20mm	1612EZ3-1T	\$408.91
16 x .140 x 1/20mm	1614EZ3-1T	\$430.85
18 x .125 x 1	1812EZ3-1T	\$508.61
18 x .140 x 1	1814EZ3-1T	\$533.33
20 x .125 x 1	2012EZ3-1T	\$588.23
20 x .140 x 1	2014EZ3-1T	\$615.63
24 x .140 x 1	2414EZ3-1T	\$818.75
24 x .155 x 1	2415EZ3-1T	\$895.59



replaces **X3-1T TURBO**



**X400 VORTEX**  
hard materials



**SUPREME BLADE**

- 9mm (.354") rim height

**Application(s)**

- Old, Hard Concrete, Hard Brick/Pavers, Stone (Granite), Other Hard Materials



SIZE	PART #	LIST PRICE
12 x .125 x 20mm	1212BDVUX4-1	\$314.67
12 x .125 x 1/20mm	1212BEDVUX4-1	\$314.67
14 x .125 x 20mm	1412BDVUX4-1	\$358.65
14 x .125 x 1/20mm	1412BEDVUX4-1	\$358.65



replaces **X4-1 VORTEX**



**X100**  
refractory



**VALUE BLADE**

- 10mm (.394") segment height

**Application(s)**

- Hard Material, Hard Brick/Pavers, Refractory, Firebrick



SIZE	PART #	LIST PRICE
12 x .110 x 1/20mm	1211EX1-1E	\$173.58
12 x .125 x 20mm	1212BX1-1E	\$181.74
12 x .125 x 1/20mm	1212EX1-1E	\$181.74
14 x .110 x 1/20mm	1411EX1-1E	\$224.62
14 x .125 x 20mm	1412BX1-1E	\$234.84
14 x .125 x 1/20mm	1412EX1-1E	\$234.84
16 x .125 x 1/20mm	1612EX1-1E	\$326.61
16 x .140 x 1	1614EX1-1E	\$361.63
18 x .125 x 1	1812EX1-1E	\$430.33
20 x .125 x 1	2012EX1-1E	\$485.23



replaces **X1-1E**



**X400**  
refractory



**SUPREME BLADE**

- 10mm (.394") segment height

**Application(s)**

- Hard Material, Hard Brick/Pavers, Refractory, Firebrick



SIZE	PART #	LIST PRICE
12 x .110 x 1/20mm	1211EX4-1E	\$284.86
12 x .125 x 20mm	1212BX4-1E	\$304.26
12 x .125 x 1/20mm	1212EX4-1E	\$304.26
14 x .110 x 1/20mm	1411EX4-1E	\$348.16
14 x .125 x 20mm	1412BX4-1E	\$367.57
14 x .125 x 1/20mm	1412EX4-1E	\$367.57
16 x .125 x 1/20mm	1612EX4-1E	\$455.58
16 x .140 x 1	1614EX4-1E	\$611.09
18 x .125 x 1	1812EX4-1E	\$558.03
20 x .125 x 1	2012EX4-1E	\$644.94
24 x .155 x 1	2415EX4-1E	\$923.95



replaces **X4-1E**



**ES100**  
general purpose



**ECONOMY BLADE**

- 12mm (.472") segment height
- Sintered

**Application(s)**

- Cured Concrete, Brick, Block



SIZE	PART #	LIST PRICE
12 x .125 x 20mm	1212BSI	\$107.20
12 x .125 x 1/20mm	1212ESI	\$107.20
14 x .125 x 20mm	1412BSI	\$117.42
14 x .125 x 1/20mm	1412ESI	\$117.42



replaces **ESI**



**ES101 TURBO**  
general purpose



**ECONOMY BLADE**

- 12mm (.472") segment height
- Sintered

**Application(s)**

- Cured Concrete, Brick, Block
- Same quality as our regular ESI series, with turbo segments*



SIZE	PART #	LIST PRICE
12 x .125 x 20mm	1212BSIZ	\$107.22
12 x .125 x 1/20mm	1212ESIZ	\$107.22
14 x .125 x 20mm	1412BSIZ	\$117.42
14 x .125 x 1/20mm	1412ESIZ	\$117.42



replaces **ESIZ TURBO**





**Y100**  
general purpose

**QUALITY BLADE**

- 12mm (.472") segment height

**Application(s)**

- Cured Concrete, Brick, Block



SIZE	PART #	LIST PRICE
12 X .125 X 20mm	1212BLY1-2	\$122.36
12 X .125 X 1/20mm	1212ELY1-2	\$122.36
14 X .125 X 20mm	1412BLY1-2	\$133.39
14 X .125 X 1/20mm	1412ELY1-2	\$133.39



replaces **LY1-2**



**Y110**  
general purpose

**QUALITY BLADE**

- 12mm (.472") segment height

**Application(s)**

- Cured Concrete, Brick, Block



SIZE	PART #	LIST PRICE
12 x .125 x 20mm	1212BY1-2	\$138.84
12 x .125 x 1/20mm	1212EY1-2	\$138.84
14 x .110 x 1/20mm	1411EY1-2	\$158.21
14 x .125 x 20mm	1412BY1-2	\$173.56
14 x .125 x 1/20mm	1412EY1-2	\$173.56
16 x .125 x 20mm	1612BY1-2	\$286.34
16 x .125 x 1/20mm	1612EY1-2	\$286.34
18 x .125 x 1	1812EY1-2	\$371.42
20 x .140 x 1	2014EY1-2	\$439.09



replaces **Y1-2**



**Y111 TURBO**  
general purpose

**QUALITY BLADE**

- 12mm (.472") segment height
- Segmented turbo for balance between life and speed of cut

**Application(s)**

- Cured Concrete, Brick, Block



SIZE	PART #	LIST PRICE
12 X .125 X 20mm	1212BDZUY2-2KV	\$138.84
12 X .125 X 1/20mm	1212BEDZUY2-2KV	\$138.84
14 X .125 X 20mm	1412BDZUY2-2KV	\$173.56
14 X .125 X 1/20mm	1412BEDZUY2-2KV	\$173.56
16 X .125 X 1/20mm	1612BEDZUY2-2KV	\$326.72
18 X .125 X 1	1812EDZUY2-2KV	\$414.58
20 X .140 X 1	2014EDZUY2-2KV	\$459.48



replaces **Y2-2KV**



**Y121 TURBO**  
general purpose

**QUALITY BLADE**

- 15mm (.591") segment height
- Alternating turbo/regular segments

**Application(s)**

- Cured Concrete, Brick, Block



SIZE	PART #	LIST PRICE
12 x .125 x 1/20mm	1212EYZ-15	\$204.20
14 x .125 x 20mm	1412BYZ-15	\$255.25
14 x .125 x 1/20mm	1412EYZ-15	\$255.25
16 x .125 x 1/20mm	1612EYZ-15	\$329.33
20 x .140 x 1	2014EYZ-15	\$548.89



replaces **YZ-15**



**X350**  
general purpose

**PREMIUM BLADE**

- 12mm (.472") segment height

**Application(s)**

- Cured Concrete, Brick, Block



SIZE	PART #	LIST PRICE
12 x .125 x 20mm	1211EX3.5-2	\$232.78
12 x .125 x 20mm	1212BX3.5-2	\$232.78
12 x .125 x 1/20mm	1212EX3.5-2	\$232.78
12 x 187 x 1	1218EX3.5-2	\$454.02
12 x .250 x 1	1225EX3.5-2	\$479.88
12 x .375 x 1	1237EX3.5-2	\$807.21
12 x .500 x 1	1250EX3.5-2	\$918.14
14 x .110 x 1/20mm	1411EX3.5-2	\$238.75
14 x .125 x 20mm	1412BX3.5-2	\$290.98
14 x .125 x 1/20mm	1412EX3.5-2	\$290.98
14 x .187 x 1	1418EX3.5-2	\$478.85
14 x .250 x 1	1425EX3.5-2	\$640.15
14 x .375 x 1	1437EX3.5-2	\$998.89
14 x .500 x 1	1450EX3.5-2	\$1,180.48
16 x .125 x 20mm	1612BX3.5-2	\$377.80
16 x .125 x 1/20mm	1612EX3.5-2	\$377.80
16 x .140 x 1/20mm	1614EX3.5-2	\$396.14
16 x .250 x 1	1625EX3.5-2	\$758.60
18 x .125 x 1	1812EX3.5-2	\$471.12
18 x .140 x 1	1814EX3.5-2	\$492.13
18 x .250 x 1	1825EX3.5-2	\$1,225.19
20 x .125 x 1	2012EX3.5-2	\$547.03
20 x .140 x 1	2014EX3.5-2	\$570.83



replaces **X3-2**



**X400 VORTEX**  
general purpose

**SUPREME BLADE**

- 9mm (.354") rim height
- Unique vortex turbo design for fast, smooth cutting

**Application(s)**

- Cured Concrete, Brick, Block



SIZE	PART #	LIST PRICE
12 x .125 x 20mm	1212BDVUX4-2	\$294.58
12 x .125 x 1/20mm	1212BEDVUX4-2	\$294.58
14 x .125 x 20mm	1412BDVUX4-2	\$335.78
14 x .125 x 1/20mm	1412BEDVUX4-2	\$335.78



replaces **X4-2 VORTEX**



**ZENESIS™**  
general purpose 

**ZENESIS™ BLADE**

- ZENESIS™ 2.0 Patterned Technology for maximum performance
- 12mm (.472") segment height

**Application(s)**

- Cured Concrete, Brick, Block



SIZE	PART #	LIST PRICE
12 x .125 x 20mm	1212BDUX4-2	\$375.02
12 x .125 x 1/20mm	1212BEDUX4-2	\$375.02
14 x .125 x 20mm	1412BDUX4-2	\$457.42
14 x .125 x 1/20mm	1412BEDUX4-2	\$457.42
16 x .125 x 20mm	1612BDUX4-2	\$548.89
16 x .125 x 1/20mm	1612BEDUX4-2	\$548.89
16 x .140 x 1	1614BEDUX4-2	\$622.12
18 x .125 x 1	1812EDUX4-2	\$658.69
18 x .140 x 1	1814EDUX4-2	\$731.82
20 x .125 x 1	2012EDUX4-2	\$951.41
20 x .140 x 1	2014EDUX4-2	\$1,006.31
20 5/8 x .140 x 1	20514EDUX4-2	\$1,006.31
24 x .140 x 1	2414EDUX4-2	\$1,106.94



replaces **ZX4-2**



**Y100**  
abrasive materials 

**QUALITY BLADE**

- Recommended for 5-13hp saws
- 10mm (.394") segment height

**Application(s)**

- Abrasive Concrete, Soft/Abrasive Aggregates, Green Concrete



SIZE	PART #	LIST PRICE
12 x .125 x 1	1212EY2-3	\$159.44
14 x .125 x 1	1412EY2-3	\$199.92



replaces **Y2-3**



**X300**  
abrasive materials 

**PREMIUM BLADE**

- 12mm (.472") segment height

**Application(s)**

- Abrasive Cured Concrete, Soft Aggregates, Block, Green Concrete, Sand Stone, Lime Stone



SIZE	PART #	LIST PRICE
12 x .125 x 1	1212EX3-3	\$233.81
14 x .125 x 1	1412EX3-3	\$290.98
16 x .125 x 1	1612EX3-3	\$391.92
18 x .125 x 1	1812EX3-3	\$471.53
20 x .125 x 1	2012EX3-3	\$549.30
20 x .140 x 1	2014EX3-3	\$567.63
24 x .140 x 1	2414EX3-3	\$791.04
24 x .155 x 1	2415EX3-3	\$892.70



replaces **X3-3**



**ES100**  
asphalt



**Y110**  
asphalt



**X100**  
asphalt

**ECONOMY BLADE**

- 10mm (.394") or 12mm (.472") segment height
- Equipped with wedge segment undercut protection

**Application(s)**

- Asphalt, Green Concrete (longer life)



SIZE	PART #	LIST PRICE
14" x .125 x 1/20mm, 10mm	1412ESIT-4	\$149.30
14" x .125 x 1/20mm, 12mm	1412ESI-4	\$156.51



replaces **ESI-4**

**QUALITY BLADE**

- 12mm (.472") segment height
- 9.4mm U slot, drop segment

**Application(s)**

- Asphalt, Green Concrete (longer life)



SIZE	PART #	LIST PRICE
12 x .125 x 1/20mm	1212EY2-4T	\$183.13
14 x .125 x 1/20mm	1412EY2-4T	\$224.64
16 x .125 x 1/20mm	1612EY2-4T	\$302.20
18 x .125 x 1	1812EY2-4T	\$402.94



replaces **Y1-4 & Y2-4**

**VALUE BLADE**

- 8mm (.315") segment height
- Equipped with insert undercut protection

**Application(s)**

- Asphalt, Green Concrete (longer life)



SIZE	PART #	LIST PRICE
12 x .110 x 1/20mm	1211EX1-4	\$276.66
12 x .125 x 20mm	1212BX1-4	\$301.17
12 x .125 x 1/20mm	1212EX1-4	\$301.17
14 x .110 x 20mm	1411BX1-4	\$294.07
14 x .110 x 1/20mm	1411EX1-4	\$294.07
14 x .125 x 20mm	1412BX1-4	\$350.20
14 x .125 x 1/20mm	1412EX1-4	\$350.20
16 x .125 x 1/20mm	1612EX1-4	\$366.89



replaces **X1-4**



**X400**  
asphalt



**SUPREME BLADE**

- 10mm (.394") segment height
- Equipped with wedge segment undercut protection

**Application(s)**

- Asphalt, Green Concrete (longer life)



SIZE	PART #	LIST PRICE
12 x .110 x 1/20mm	1211EX4-4	\$370.59
12 x .125 x 20mm	1212BX4-4	\$410.46
12 x .125 x 1/20mm	1212EX4-4	\$410.46
14 x .110 x 1/20mm	1411EX4-4	\$460.51
14 x .125 x 20mm	1412BX4-4	\$510.47
14 x .125 x 1/20mm	1412EX4-4	\$510.47
14 x .187 x 1	1418EX4-4	\$933.08
14 x .250 x 1	1425EX4-4	\$933.08
14 x .375 x 1	1437EX4-4	\$1,358.47
16 x .125 x 1/20mm	1612EX4-4	\$581.85
16 x .140 x 1	1614EX4-4	\$632.11
18 x .125 x 1	1812EX4-4	\$692.51
20 x .125 x 1	2012EX4-4	\$792.22



replaces **X4-4**



**AP100 COMBO CUT**  
all purpose



**QUALITY BLADE**

- 12mm (.472") segment height
- Equipped with deep segment undercut protection
- Alternating turbo segments for faster cutting

**Application(s)**

- Cured Concrete, Asphalt, Abrasive Concrete, Green Concrete, Brick/Block



SIZE	PART #	LIST PRICE
12 X .125 X 1/20mm	1212ELY2-AP	\$170.68
12 X .125 X 20mm	1212BLY2-AP	\$170.68
14 X .125 X 1/20mm	1412ELY2-AP	\$205.41
14 X .125 X 20mm	1412BLY2-AP	\$205.41
16 X .125 X 1/20mm	1612ELY2-AP	\$310.43



replaces **Y2-AP**



**AP200**  
all purpose



**HEAVY DUTY BLADE**

- 10mm (.394") segment height
- All purpose blade specializing in harder applications
- Equipped with wedge segment undercut protection

**Application(s)**

- Cured Concrete, Asphalt, Abrasive Concrete, Green Concrete, Brick/Block



SIZE	PART #	LIST PRICE
14 x .125 x 20mm	1412BX1-AP	\$306.32
14 x .125 x 1/20mm	1412EX1-AP	\$306.32
16 x .125 x 1/20mm	1612EX1-AP	\$389.18



replaces **X1-AP RED**



**AP201 TURBO**  
all purpose



**HEAVY DUTY BLADE**

- 15mm (.591") segment height
- Equipped with wedge segment undercut protection
- Alternating turbo segments for faster cutting

**Application(s)**

- Cured Concrete, Asphalt, Abrasive Concrete, Green Concrete, Brick/Block



SIZE	PART #	LIST PRICE
12 x .125 x 1/20mm	1212EYZ-AP	\$228.66
14 x .125 x 20mm	1412BYZ-AP	\$285.93
14 x .125 x 1/20mm	1412EYZ-AP	\$285.93
16 x .125 x 1/20mm	1612EYZ-AP	\$486.98
18 x .125 x 1	1812EYZ-AP	\$618.41



replaces **YZ-AP (ALT SEG)**



**AP300**  
all purpose



**PREMIUM BLADE**

- 10mm (.394") segment height
- Equipped with wedge segment undercut protection

**Application(s)**

- Cured Concrete, Asphalt, Abrasive Concrete, Green Concrete, Brick/Block



SIZE	PART #	LIST PRICE
12 x .110 x 1/20mm	1211BEDUX3-AP	\$319.61
12 x .125 x 20mm	1212BDUX3-AP	\$336.91
12 x .125 x 1/20mm	1212BEDUX3-AP	\$336.91
14 x .125 x 20mm	1412BDUX3-AP	\$408.40
14 x .125 x 1/20mm	1412BEDUX3-AP	\$408.40
16 x .125 x 20mm	1612BDUX3-AP	\$439.09
16 x .125 x 1/20mm	1612BEDUX3-AP	\$439.09
18 x .125 x 1	1812EDUX3-AP	\$668.78



replaces **X1-AP**



**ZENESIS™ V SERIES**  
all purpose



**ZENESIS™ BLADE**

- Exclusive "patterned" technology for maximum performance
- 15mm (.590") segment height
- Equipped with deep segment undercut protection

**Application(s)**

- Cured Concrete, Asphalt, Abrasive Concrete, Green Concrete, Brick/Block



SIZE	PART #	LIST PRICE
12 X .125 X 20mm	1212BDUX4-AP2	\$403.60
12 X .125 X 1/20mm	1212BEDUX4-AP2	\$403.60
14 X .125 X 20mm	1412BDUX4-AP2	\$420.40
14 X .125 X 1/20mm	1412BEDUX4-AP2	\$420.40
16 X .125 X 20mm	1612BDUX4-AP2	\$517.95
16 X .125 X 1/20mm	1612BEDUX4-AP2	\$517.95
18 X .125 X 1	1812EDUX4-AP2	\$602.87



replaces **V SERIES ALL PURPOSE**



# **SURFACE PREPARATION**



**SINGLE ROW X100**

**VALUE CUP WHEEL**

- Single row for faster/more aggressive grinding of concrete & masonry applications



SIZE	SEGS	PART #	LIST PRICE
4 x 7/8-5/8	8	04CDDXS1	\$60.80
4 x 5/8-11	8	04HDDXS1	\$60.80
4 1/2 x 7/8-5/8	8	45CDDXS1	\$58.00
4 1/2 x 5/8-11	8	45HDDXS1	\$58.00
5 x 7/8-5/8	10	05CDDXS1	\$66.53
5 x 5/8-11	10	05HDDXS1	\$66.53
7 x 7/8-5/8	12	07CDDXS1	\$104.11
7 x 5/8-11	12	07HDDXS1	\$104.11



replaces **SINGLE ROW-X1**



**DOUBLE ROW X100**

**VALUE CUP WHEEL**

- Double row for smoothest grinding of concrete & masonry applications



SIZE	SEGS	PART #	LIST PRICE
4 x 7/8-5/8	16	04CDDDX1	\$94.50
4 x 5/8-11	16	04HDDDX1	\$94.50
4 1/2 x 7/8-5/8	16	45CDDDX1	\$108.97
4 1/2 x 5/8-11	16	45HDDDX1	\$108.97
5 x 7/8-5/8	20	05CDDDX1	\$112.86
5 x 5/8-11	20	05HDDDX1	\$112.86
7 x 7/8-5/8	24	07CDDDX1	\$160.06
7 x 5/8-11	24	07HDDDX1	\$160.06



replaces **DOUBLE ROW-X1**



**SINGLE TURBO X100**

**VALUE CUP WHEEL**

- Single turbo style for faster/more aggressive grinding of concrete & masonry applications



SIZE	SEGS	PART #	LIST PRICE
4 x 7/8-5/8	8	04CDDGSX1	\$45.14
4 x 5/8-11	8	04HDDGSX1	\$45.14
4 1/2 x 7/8-5/8	9	45CDDGSX1	\$49.14
4 1/2 x 5/8-11	9	45HDDGSX1	\$49.14
5 x 7/8-5/8	9	05CDDGSX1	\$55.10
5 x 5/8-11	9	05HDDGSX1	\$55.10
7 x 7/8-5/8	12	07CDDGSX1	\$83.92
7 x 5/8-11	12	07HDDGSX1	\$83.92



replaces **SINGLE TURBO-X1**





**DOUBLE TURBO X100**

**VALUE CUP WHEEL**

- Double turbo style for smoothest grinding of concrete & masonry applications



SIZE	SEGS	PART #	LIST PRICE
4 x 7/8-5/8	14	04CDDGDX1	\$64.69
4 x 5/8-11	14	04HDDGDX1	\$64.69
4 1/2 x 7/8-5/8	18	45CDDGDX1	\$81.11
4 1/2 x 5/8-11	18	45HDDGDX1	\$81.11
5 x 7/8-5/8	18	05CDDGDX1	\$87.26
7 x 7/8-5/8	24	07CDDGDX1	\$118.69
7 x 5/8-11	24	07HDDGDX1	\$118.69
7 x 5/8-11, 1/2" HUB	24	07HDDGDX1L	\$178.42



replaces **DOUBLE TURBO-X1**



**TURBO FAN X100**

**VALUE CUP WHEEL**

- New "L shape" turbo fan design to help disperse materials being ground



SIZE	PART #	LIST PRICE
4 x 7/8-5/8	04CDFCX1	\$136.62
4 x 5/8-11	04HDFCX1	\$136.62
4 1/2 x 5/8-11	45HDFCX1	\$154.33
5 x 5/8-11	05HDFCX1	\$167.51
7 x 7/8-5/8	07CDFCX1	\$238.03
7 x 5/8-11	07HDFCX1	\$238.03



replaces **TURBO FAN-X1-1**



**T-SEG CUP WHEEL**

**PREMIUM CUP WHEEL**

- "T-seg" design for fast/aggressive grinding

**Application(s)**

- Concrete, Brick & Block



SIZE	PART #	LIST PRICE
4 x 7/8-5/8	04CDTC	\$132.19
4 x 5/8-11	04HDTC	\$132.19
4 1/2 x 7/8-5/8	45CDTC	\$149.90
4 1/2 x 5/8-11	45HDTC	\$149.90
5 x 7/8-5/8	05CDTC	\$167.51
5 x 5/8-11	05HDTC	\$167.51
7 x 7/8-5/8	07CDTC	\$202.82
7 x 5/8-11	07HDTC	\$202.82



**ARROW SEG CUP WHEEL**

**PREMIUM CUP WHEEL**

- 10mm (.394") segment height
- Arrow segment

**Application(s)**

- Concrete, Brick, Block, Stone



SIZE	PART #	LIST PRICE
7 x 7/8-5/8	07CARX3	\$220.43
7 x 5/8-11	07HARX3	\$220.43



**PCD X100**

**VALUE CUP WHEEL**

- 10mm (.394") segment height

**Application(s)**

- Epoxy / Paint Removal



SIZE	PART #	LIST PRICE
4 x 7/8-5/8	04CPCD2	\$259.46
4 x 5/8-11	04HPCD2	\$259.46
4 1/2 x 7/8-5/8	45CPCD2	\$295.35
4 1/2 x 5/8-11	45HPCD2	\$295.35
5 x 7/8-5/8	05CPCD2	\$332.47
5 x 5/8-11	05HPCD2	\$332.47
6 x 7/8-5/8	06CPCD2	\$375.31
6 x 5/8-11	06HPCD2	\$375.31
7 x 7/8-5/8	07CPCD2	\$406.44
7 x 5/8-11	07HPCD2	\$406.44



**PCD X200**

**HEAVY DUTY CUP WHEEL**

- 10mm (.394") segment height

**Application(s)**

- Epoxy / Paint Removal



SIZE	PART #	LIST PRICE
4 x 5/8-11	04HPCD3	\$342.86
4 1/2 x 5/8-11	45HPCD3	\$384.84
5 x 5/8-11	05HPCD3	\$408.16
7 x 5/8-11	07HPCD3	\$506.12



**PCD X300**

**PREMIUM CUP WHEEL**

- 10mm (.394") segment height

**Application(s)**

- Epoxy / Paint Removal



SIZE	PART #	LIST PRICE
4 x 7/8-5/8	04CPCD2P	\$338.55
4 x 5/8-11	04HPCD2P	\$338.55
4 1/2 x 7/8-5/8	45CPCD2P	\$357.94
4 1/2 x 5/8-11	45HPCD2P	\$357.94
5 x 7/8-5/8	05CPCD2P	\$436.41
5 x 5/8-11	05HPCD2P	\$436.41
6 x 7/8-5/8	06CPCD2P	\$528.98
6 x 5/8-11	06HPCD2P	\$528.98
7 x 7/8-5/8	07CPCD2P	\$648.89
7 x 5/8-11	07HPCD2P	\$648.89



**S CUP**

**SUPREME CUP WHEEL**

- 10mm (.394") segment height
- 5/8" threaded or 7/8" non-threaded
- 16/20 grit, 30/40 grit, 60/80 grit, 120/150 grit available
- Achieve very aggressive grinding, and fast stock removal
- Leaves an inform finish without swirl marks
- Great for the first steps in polishing
- Holes help with dust extraction

**Application(s)**

- Concrete / Edge Grinding



SIZE	PART #	LIST PRICE
5 x 7/8	05CSZX3-120140	\$126.00
5 x 5/8-11	05HSZX3-120140	\$126.00
5 x 7/8	05CSZX3-1618	\$126.00
5 x 7/8-11	05HSZX3-1618	\$126.00
5 x 7/8	05CSZX3-3040	\$126.00
5 x 7/8-11	05HSZX3-3040	\$126.00
5 x 7/8	05CSZX3-6080	\$126.00
5 x 7/8-11	05HSZX3-6080	\$126.00
7 x 7/8	07CSZX3-120140	\$203.50
7 x 5/8-11	07HSZX3-120140	\$203.50
7 x 7/8	07CSZX3-1618	\$203.50
7 x 5/8-11	07HSZX3-1618	\$203.50
7 x 7/8	07CSZX3-3040	\$203.50
7 x 5/8-11	07HSZX3-3040	\$203.50
7 x 7/8	07CSZX3-6080	\$203.50
7 x 5/8-11	07HSZX3-6080	\$203.50



**GRINDING BLOCKS**

**PREMIUM BLOCK**

- For grinding of concrete floors
- Designed to fit the industry's most popular machines



SIZE	PART #	LIST PRICE
2" x 2" x 4" (Med Bond)	GB224-2	\$322.37
2" x 2" x 4" (Hard Bond)	GB224-3	\$340.51



**GRINDING HEADS**

10 seg

**PREMIUM HEAD**

- For grinding of concrete floors
- Equipped with special bolt hole pattern to fit industry's most popular machines



SIZE	SEGS	BOND	PART #	LIST PRICE
10 x 5"	10	Medium	DVCCM1001	\$294.10
10 x 5"	10	Hard	DVCCM1002	\$294.10

used to be **CCM (10SEG)**



**GRINDING HEADS**

20 seg

**PREMIUM HEAD**

- For grinding of concrete floors
- Equipped with special bolt hole pattern to fit industry's most popular machines



SIZE	SEGS	BOND	PART #	LIST PRICE
10 x 5"	20	Medium	DVCCM2001	\$420.45
10 x 5"	20	Hard	DVCCM2002	\$420.45

SIZE	SEGS	BOND	PART #	LIST PRICE
10 x 5" turbo segs	20	Medium	DVCCM2009	\$504.60

used to be **CCM (20SEG)**



**DUST SHROUD**

- Suitable for major brands.
- Made by high quality PVC and Nylon to ensure long operation and light weight.
- Designed for easy install and use.
- Brush rings to keep dust away.
- This shroud does not fit grinding cup wheels with a height greater than 1.37".

SIZE	PART #	LIST PRICE
5" Sliding Type with brush	05DSHROUD	\$127.30
7" Sliding Type with brush	07DSHROUD	\$145.00

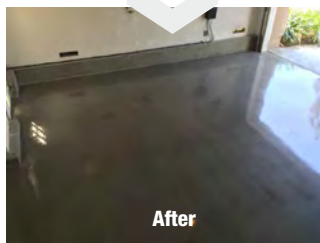
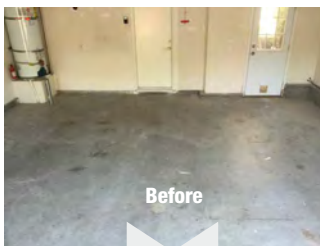

**RESIN PADS**



**METAL PADS**



**WING PADS**

**POLISHING PADS**

- Velcro for easy attachment / detachment, no tools required.
- 30 grit to 3000 grit.
- Simple to use and light weight.
- Great for smaller jobs or tight places where larger machines are not practical.
- Basements, second stories or anywhere you can't get a large machine.
- Get professional results with a lighter machine.
- Great for beginners or rental companies.
- Large heavy concrete polishing machines can achieve an 80° reading on a gloss meter. Wing pads can achieve this same level of shine.
- Designed for use with 17" floor sanders. 17" discs also available



GRIT	PART #	BUFFER SIZE	LIST PRICE
<b>METAL PADS</b>			
25	WPM-25	17"	\$55.27
30	WPM-30	17"	\$37.80
60	WPM-60	17"	\$37.80
100	WPM-100	17"	\$37.80
<b>RESIN PADS</b>			
50	WPR-50	17"	\$18.90
100	WPR-100	17"	\$18.90
200	WPR-200	17"	\$18.90
400	WPR-400	17"	\$18.90
800	WPR-800	17"	\$18.90
1500	WPR-1500	17"	\$18.90
3000	WPR-3000	17"	\$18.90

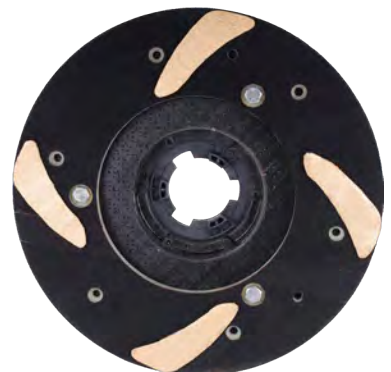
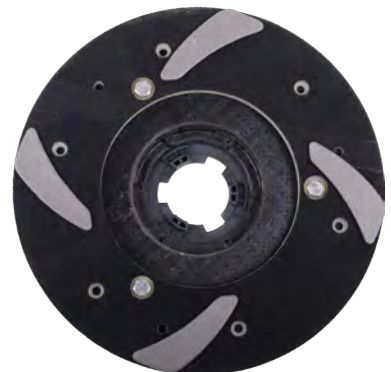



**F.A.S.T. SYSTEM**

concrete polishing diamonds

Not just another concrete polishing system Our Proprietary F.A.S.T. (Flexible Angle Segment Technology) System makes changing segments fast and easy. It is the only system with user selectable segment angle. With each segment angle producing different grinding speed and surface finish, user can select the best segment angle for the job.

**SEGMENT CONFIGURATIONS**



**HORIZONTAL**

Aggressiveness: ●●●●●  
 Scratch Pattern: rough scratch pattern  
*Ideal for grinding down or surface re-coating*



**SLANT**

Aggressiveness: ●●●●○  
 Scratch Pattern: shallow, smooth scratch pattern  
*Ideal for preparing floor for polishing/finishing*



**COMBINATION: VERTICAL & SLANT**

Aggressiveness: ●●●○●  
 Scratch Pattern: shallowest & smoothest scratch pattern  
*Delivers best surface finish while maintaining aggressive grinding speed*



**VERTICAL**

Aggressiveness: ●○○○○  
 Scratch Pattern: shallowest & smoothest scratch pattern  
*Ideal for showroom and other high-end applications*

		METAL SEGMENT				PCD SEGMENT
APPLICATION		CONCRETE VERY HARD	HARD	MEDIUM HARD	SOFT	ADHESIVE, URETHANE, EPOXY, PAINT REMOVAL
GRIT	16/18 Price: \$51.00	FGPDV-1618-05-CHC \$51.00	FGPDV-1618-1-HC \$51.00	FGPDV-1618-2-MC \$51.00	FGPDV-1618-4-SC \$51.00	FGPDV-PCD1 \$104.35
	30/40 Price: \$51.00	FGPDV-3040-05-CHC \$51.00	FGPDV-3040-1-HC \$51.00	FGPDV-3040-2-MC \$51.00	FGPDV-3040-4-SC \$51.00	
	60/80 Price: \$51.00	FGPDV-6080-05-CHC \$51.00	FGPDV-6080-1-HC \$51.00	FGPDV-6080-2-MC \$51.00	FGPDV-6080-4-SC \$51.00	FGPDV-PCD2 \$118.35
	120/150 Price: \$51.00	FGPDV-120150-05-CHC \$51.00	FGPDV-120150-1-HC \$51.00	FGPDV-120150-2-MC \$51.00	FGPDV-120150-4-SC \$51.00	

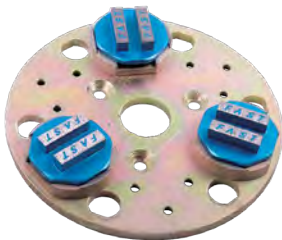

3-DIAMOND HOLDER PLATE



F.A.S.T. SYSTEM FULL PACKAGE BOX.

**AGGRESSIVENESS SCALE**

- Most aggressive grinding
- Aggressive grinding
- Best transitional grinding
- Least aggressive grinding



**HYBRID METALLIC  
POLISHING PADS**

Utilizes a hybrid bond of metal and resin to remove any remaining scratches and prepare the floor for final polishing.

**Available in 30-400 grit sizes.**

GRIT SIZE	PART #	DIAMETER	PRICE
GRIT 30	3MPPD-30	3"	\$33.99
GRIT 50	3MPPD-50	3"	\$33.99
GRIT 100	3MPPD-100	3"	\$41.56
GRIT 200	3MPPD-200	3"	\$41.56
GRIT 400	3MPPD-400	3"	\$41.56



**RESIN  
POLISHING PADS**

Used as a final polish, the resin bonded pads are specially designed for a slow wear rate, ensuring long pad life.

**Available in 50-3000 grit sizes.**

GRIT SIZE	PART #	DIAMETER	PRICE
GRIT 50	3PPPD-50	3"	\$29.51
GRIT 100	3PPPD-100	3"	\$33.99
GRIT 200	3PPPD-200	3"	\$33.99
GRIT 400	3PPPD-400	3"	\$33.99
GRIT 800	3PPPD-800	3"	\$34.35
GRIT 1500	3PPPD-1500	3"	\$34.35
GRIT 3000	3PPPD-3000	3"	\$34.35



**DRY WHITE RESIN  
POLISHING PADS**

Used as a final polish, the resin bonded pads are specially designed for a slow wear rate, ensuring long pad life.

**Available in 50-3000 grit sizes.**

GRIT SIZE	PART #	DIAMETER	PRICE
GRIT 50	3WPPD-50	3"	\$48.77
GRIT 100	3WPPD-100	3"	\$48.77
GRIT 200	3WPPD-200	3"	\$48.77
GRIT 400	3WPPD-400	3"	\$48.77
GRIT 800	3WPPD-800	3"	\$48.77
GRIT 1500	3WPPD-1500	3"	\$48.77
GRIT 3000	3WPPD-3000	3"	\$48.77



**DUAL-PURPOSE  
RESIN PADS**

Velcro with interchangeable pads with varying diamond grit for grinding and polishing of concrete, cement overlays, and stone floors. We offer seven different grit sizes, from 50 to 3000. Once you finish with one grit size, simply pull off and put on the next pad. This eliminates the need to change the entire pad every time.

**Application(s)**

- Grit 50-200: Grinding
- Grit 400: Hybrid-Grinding Polishing
- Grit 800-3000: Polishing

GRIT SIZE	PART #	DIAMETER	LIST PRICE
Grit 50	07DPPPWD-50	7"	\$96.82
Grit 100	07DPPPWD-100	7"	\$96.82
Grit 200	07DPPPWD-200	7"	\$96.82
Grit 400	07DPPPWD-400	7"	\$96.82
Grit 800	07DPPPWD-800	7"	\$96.82
Grit 1500	07DPPPWD-1500	7"	\$96.82
Grit 3000	07DPPPWD-3000	7"	\$96.82
	VELCROPAD07	7"	\$5.50

GRIT SIZE	PART #	DIAMETER	LIST PRICE
Grit 50	09DPPPWD-50	9"	\$116.39
Grit 100	09DPPPWD-100	9"	\$116.39
Grit 200	09DPPPWD-200	9"	\$116.39
Grit 400	09DPPPWD-400	9"	\$116.39
Grit 800	09DPPPWD-800	9"	\$116.39
Grit 1500	09DPPPWD-1500	9"	\$116.39
Grit 3000	09DPPPWD-3000	9"	\$116.39
	VELCROPAD09	9"	\$8.22

GRIT SIZE	PART #	DIAMETER	LIST PRICE
Grit 50	11DPPPWD-50	11"	\$132.87
Grit 100	11DPPPWD-100	11"	\$132.87
Grit 200	11DPPPWD-200	11"	\$132.87
Grit 400	11DPPPWD-400	11"	\$132.87
Grit 800	11DPPPWD-800	11"	\$132.87
Grit 1500	11DPPPWD-1500	11"	\$132.87
Grit 3000	11DPPPWD-3000	11"	\$132.87
	VELCROPAD11	11"	\$11.00



**BURNISHING PADS**

Diamond coated pads for cleaning and polishing a wide range materials such as Natural stone, Engineered stone, Terrazzo, Polished concrete. These pads will help keep your floor clean and shiny, reducing long-term maintenance costs.

GRIT SIZE	PART #	DIAMETER	LIST PRICE
Grit 400	17BPPWD-400	17"	\$75.90
Grit 800	17BPPWD-800	17"	\$75.90
Grit 1500	17BPPWD-1500	17"	\$75.90
Grit 3000	17BPPWD-3000	17"	\$75.90

GRIT SIZE	PART #	DIAMETER	LIST PRICE
Grit 400	20BPPWD-400	20"	\$92.02
Grit 800	20BPPWD-800	20"	\$92.02
Grit 1500	20BPPWD-1500	20"	\$92.02
Grit 3000	20BPPWD-3000	20"	\$92.02

GRIT SIZE	PART #	DIAMETER	LIST PRICE
Grit 400	21BPPWD-400	21"	\$102.33
Grit 800	21BPPWD-800	21"	\$102.33
Grit 1500	21BPPWD-1500	21"	\$102.33
Grit 3000	21BPPWD-3000	21"	\$102.33

GRIT SIZE	PART #	DIAMETER	LIST PRICE
Grit 400	24BPPWD-400	24"	\$123.60
Grit 800	24BPPWD-800	24"	\$123.60
Grit 1500	24BPPWD-1500	24"	\$123.60
Grit 3000	24BPPWD-3000	24"	\$123.60

GRIT SIZE	PART #	DIAMETER	LIST PRICE
Grit 400	27BPPWD-400	27"	\$140.80
Grit 800	27BPPWD-800	27"	\$140.80
Grit 1500	27BPPWD-1500	27"	\$140.80
Grit 3000	27BPPWD-3000	27"	\$140.80



**GRINDING WHEELS**

**GRINDING EDGE WHEEL**

• Fast Edge is a revolutionary design that improves the quality of edge work while reducing the scratches and gouging that metal bond cup wheels can cause. The Fast Edge system will eliminate metal bond cup wheels on most concrete polishing projects. Fast Edge is fast, light weight and easy to use resulting in a superior edge.

• Fast Edge Ceramic Cup wheels can run on most hand grinders and walk behind edge machines that use a 5" or 7" wheel with 5/8"-11 threaded connection. Please review maximum operating speed marked on our wheel and compare it to your grinder's rpm. Do not exceed the maximum operating speed of the wheel.



SIZE	GRIT	PART #	LIST PRICE
5 x 5/8"-11	30	FG-05HCW-30	\$119.24
5 x 5/8"-11	50	FG-05HCW-50	\$119.24
5 x 5/8"-11	100	FG-05HCW-100	\$119.24
5 x 5/8"-11	200	FG-05HCW-200	\$119.24
5 x 5/8"-11	400	FG-05HCW-400	\$119.24
7 x 5/8"-11	30	FG-07HCW-30	\$160.01
7 x 5/8"-11	50	FG-07HCW-50	\$160.01
7 x 5/8"-11	100	FG-07HCW-100	\$160.01
7 x 5/8"-11	200	FG-07HCW-200	\$160.01
7 x 5/8"-11	400	FG-07HCW-400	\$160.01



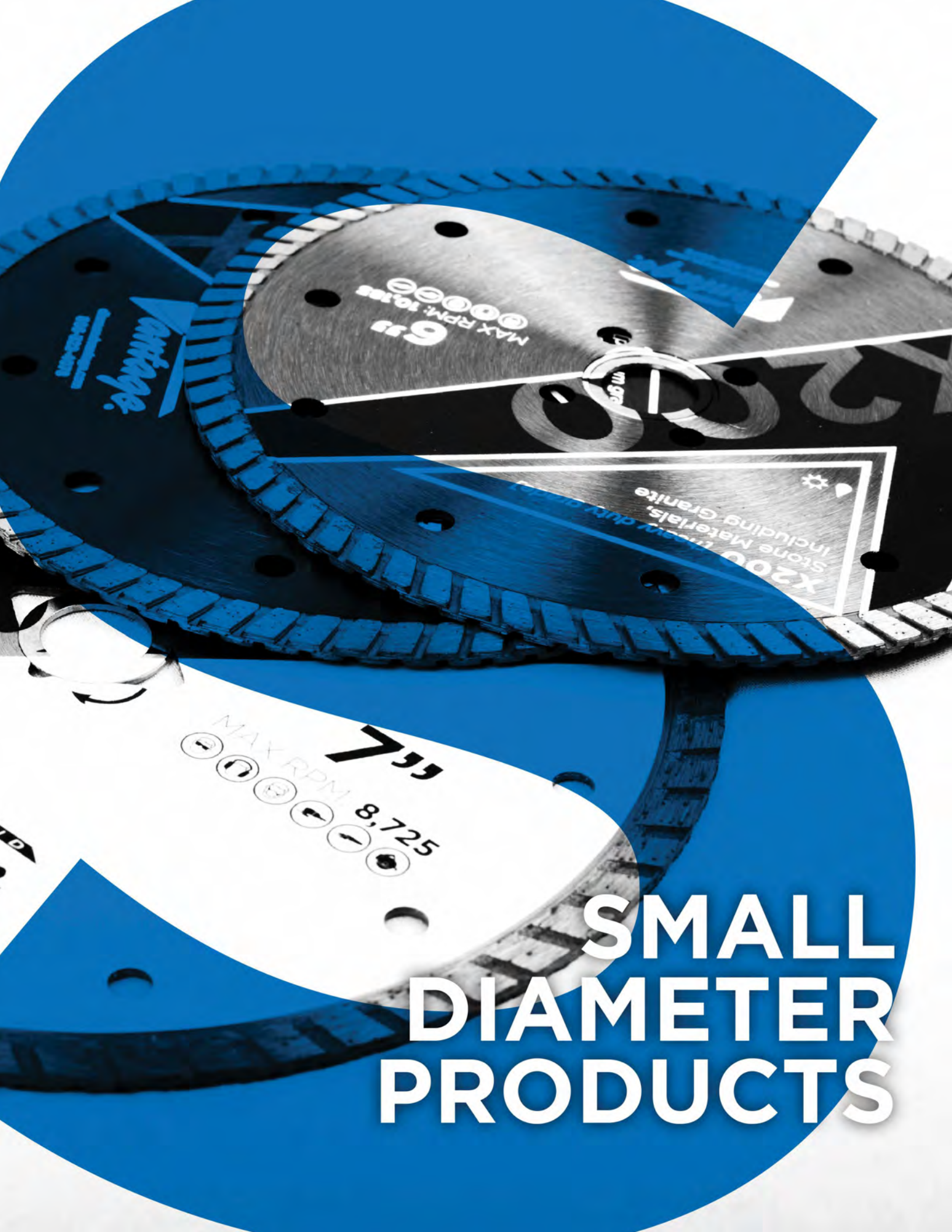

# SMALL DIAMETER PRODUCTS

### SMALL DIAMETER BLADE GRADE LEVEL CHART



### BOND SELECTION CHART (SMALL DIAMETER)

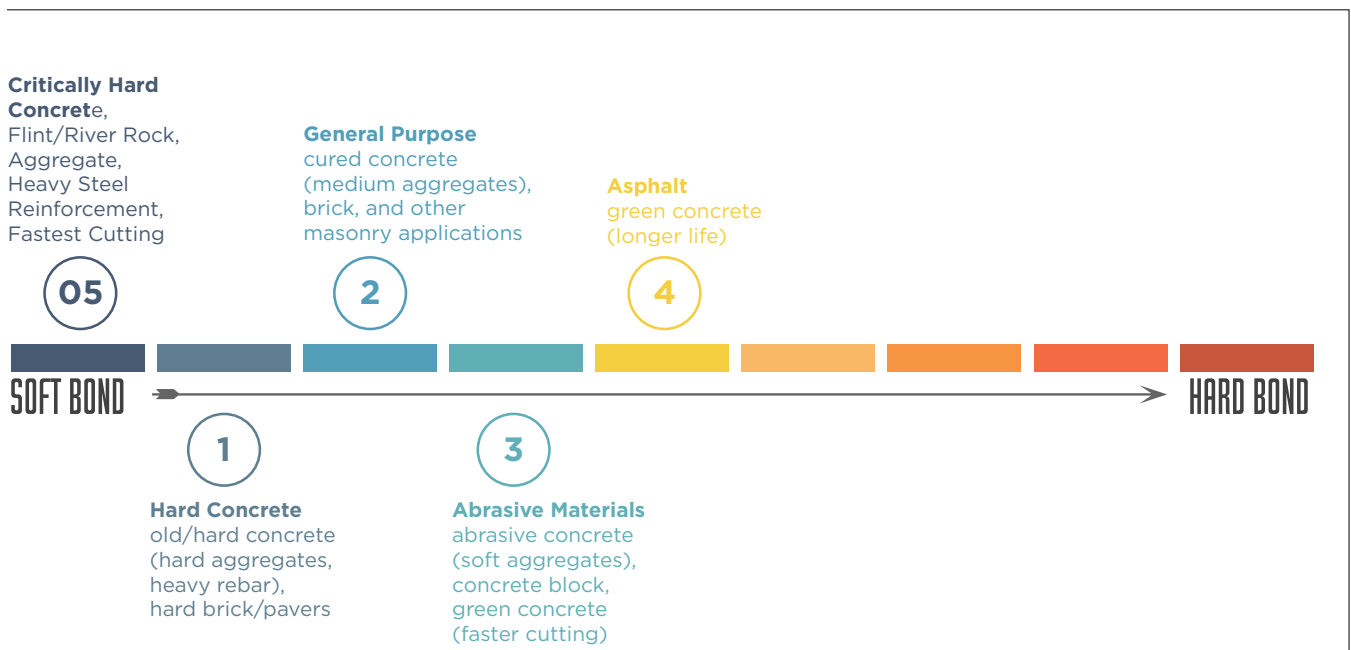



**X400**

hard material



**X401 TURBO**

hard material



**X100**

hard material



**SUPREME BLADE**

- 10mm (.394") segment height

**Application(s)**

- Hard Concrete, Reinforced Concrete Hard Brick/Pavers



SIZE	PART #	LIST PRICE
4 x .080 x 7/8-5/8	0408CDUX4-1	\$39.55
4 1/2 x .080 x 7/8-5/8	4508CDUX4-1	\$41.72
5 x .080 x 7/8-5/8	0508CDUX4-1	\$48.31
6 x .095 x 7/8-5/8	0609CDUX4-1	\$60.87
6 x .095 x U/A	0609UDUX4-1	\$60.87
7 x .095 x U/A	0709UDUX4-1	\$85.80
8 x .095 x U/A	0809UDUX4-1	\$94.76
9 x .095 x DM-5/8	0909DDUX4-1	\$112.27
10 x .095 x DM-5/8	1009DDUX4-1	\$129.27



replaces **X4-1**

**SUPREME BLADE**

- 10mm (.394") segment height

**Application(s):**

- Hard Concrete, Reinforced Concrete Hard Brick/Pavers



SIZE	PART #	LIST PRICE
4 x .080 x 7/8-5/8	0408CZ4-1	\$39.55
4 1/2 x .080 x 7/8-5/8	4508CZ4-1	\$41.72
5 x .080 x 7/8-5/8	0508CZ4-1	\$48.31
6 x .095 x 7/8-5/8	0609CZ4-1	\$60.87
7 x .095 x U/A	0709UZ4-1	\$85.80
8 x .095 x U/A	0809UZ4-1	\$94.76
10 x .095 x U/A	1009UZ4-1	\$129.27



replaces **Z4-1**

**VALUE BLADE**

- 8mm (.315") segment height

**Application(s)**

- Granite, Marble, Hard Brick, Hard Pavers



SIZE	PART #	LIST PRICE
4 x .080 x 7/8-5/8	0408CDZBX1-1	\$18.64
4 1/2 x .080 x 7/8-5/8	4508CDZBX1-1	\$19.78
5 x .080 x 7/8-5/8	0508CDZBX1-1	\$20.70
6 x .095 x U/A	0609UDZBX1-1	\$28.74
7 x .095 x U/A	0709UDZBX1-1	\$35.33



replaces **X1-1**



**X200**

hard material



**HEAVY DUTY BLADE**

- 10mm (.394") segment height

**Application(s):**

- Granite, Marble, Hard Brick, Hard Pavers



SIZE	PART #	LIST PRICE
4 x .080 x 7/8-5/8	0408CDZBX2-1	\$23.69
4 1/2 x .080 x 7/8-5/8	4508CDZBX2-1	\$25.34
5 x .080 x 7/8-5/8	0508CDZBX2-1	\$28.84
6 x .095 x 7/8-5/8	0609UDZBX2-1	\$41.72
7 x .095 x U/A	0709UDZBX2-1	\$51.40
8 x .095 x U/A	0809UDZBX2-1	\$62.01
9 x .095 x U/A	0909UDZBX2-1	\$77.97
10 x .095 x U/A	1009UDZBX2-1	\$89.40



replaces **X1-1T**



**X400 PEGASUS**

hard material



**SUPREME BLADE**

- 10mm (.394") segment height

**Application(s):**

- Hard Brick/Pavers, Stone (Granite), Hard Materials



SIZE	PART #	LIST PRICE
4 x .080 x 7/8-5/8	0408CPEGX4-1	\$50.26
4 1/2 x .080 x 7/8-5/8	4508CPEGX4-1	\$53.05
5 x .080 x 7/8-5/8	0508CPEGX4-1	\$61.29
6 x .095 x 7/8-5/8	0609CPEGX4-1	\$86.01
7 x .095 x U/A	0709UPEGX4-1	\$96.92
10 x .095 x U/A	1009UPEGX4-1	\$161.92



replaces **X4-1 PEGASUS**



**X400 VORTEX\***

hard material



**SUPREME BLADE**

- 9mm (.354") rim height

**Application(s)**

- Hard Brick/Pavers, Stone (Granite), Hard Material

\*Also available in Wavy Core



SIZE	PART #	LIST PRICE
4 x .080 x 7/8-5/8	0408CDZBX4-1	\$70.45
4 1/2 x .080 x 7/8-5/8	4508CDZBX4-1	\$74.26
5 x .080 x 7/8-5/8	0508CDZBX4-1	\$78.90
6 x .095 x 7/8-5/8	0609CDZBX4-1	\$102.69
6 x .095 x U/A	0609UDZBX4-1	\$102.69
7 x .095 x U/A	0709UDZBX4-1	\$132.66
8 x .095 x U/A	0809UDZBX4-1	\$145.44
9 x .095 x 7/8-5/8	0909CDZBX4-1	\$201.26
10 x .095 x 7/8-5/8	1009ADZBX4-1	\$203.12
10 x .095 x U/A	1009UDZBX4-1	\$203.12



replaces **X4-1 VORTEX**



**ES100**  
general purpose

**ECONOMY BLADE**

- 10mm (.394") segment height
- Sintered

**Application(s)**

- General Purpose, Brick, Block, Soft Concrete



SIZE	PART #	LIST PRICE
4 x .060 x 7/8-5/8	0406CSIT	\$13.39
4 1/2 x .060 x 7/8-5/8	4506CSIT	\$17.41
5 x .060 x 7/8-5/8	0506CSIT	\$22.04
7 x .080 x U/A	0708USIT	\$36.05
8 x .095 x U/A	0809USIT	\$43.26
10 x .095 x U/A	1009USIT	\$75.50



replaces **ESI**



**ES101 TURBO**  
general purpose

**ECONOMY BLADE**

- 10mm (.394") segment height
- Sintered

**Application(s)**

- General Purpose, Brick, Block, Soft Concrete



SIZE	PART #	LIST PRICE
4 x .080 x 7/8-5/8	0408CSZ1-2	\$16.82
4 1/2 x .080 x 7/8-5/8	4508CSZ1-2	\$18.03
5 x .080 x 7/8-5/8	0508CSZ1-2	\$19.22
6 x .090 x 7/8-5/8	0609CSZ1-2	\$26.43
7 x .095 x U/A-5/8	0709USZ1-2	\$33.63



**Y100**  
general purpose

**QUALITY BLADE**

- 10mm (.394") segment height

**Application(s)**

- Concrete, Brick, Block



SIZE	PART #	LIST PRICE
4 x .080 x 20mm	0408BDUY1-2	\$20.39
4 x .080 x 7/8-5/8	0408CDUY1-2	\$20.39
4 1/2 x .080 x 7/8-5/8	4508CDUY1-2	\$25.54
5 x .080 x 7/8-5/8	0508CDUY1-2	\$30.59
6 x .095 x 7/8-5/8	0609CDUY1-2	\$38.83
6 x .095 x U/A	0609UDUY1-2	\$38.83
7 x .095 x 7/8-5/8	0709CDUY1-2	\$45.94
7 x .095 x DM-5/8	0709DDUY1-2	\$45.94
7 x .095 x U/A	0709UDUY1-2	\$45.94
8 x .095 x DM-5/8	0809DDUY1-2	\$63.35
8 x .095 x U/A	0809UDUY1-2	\$63.35
9 x .095 x 7/8-5/8	0909CDUY1-2	\$76.53
9 x .095 x U/A	0909UDUY1-2	\$76.53
10 x .095 x 7/8-5/8	1009CDUY1-2	\$88.79
10 x .095 x U/A	1009UDUY1-2	\$88.79



replaces **Y1-2 SEG**

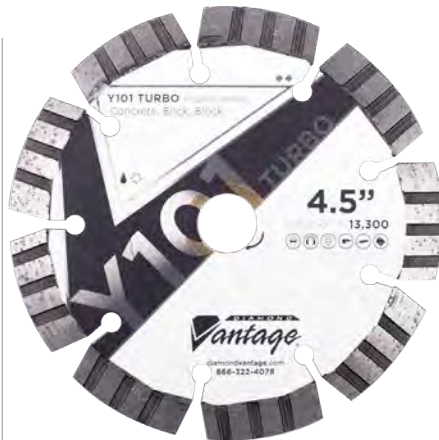

**Y101 TURBO**  
general purpose



**X400**  
general purpose



**Y100**  
general purpose

**QUALITY BLADE**

- 10mm (.394") segment height

**Application(s)**

- Concrete, Brick, Block

**SUPREME BLADE**

- 10mm (.394") segment height

**Application(s)**

- Concrete, Brick, Block

**QUALITY BLADE**

- 7mm (.276") turbo rim height

**Application(s):**

- Concrete, Brick, Block



SIZE	PART #	LIST PRICE
4 x .080 x 7/8-5/8	0408CZY1-2	\$21.42
4 1/2 x .080 x 7/8-5/8	4508CZY1-2	\$26.78
5 x .080 x 7/8-5/8	0508CZY1-2	\$32.14
6 x .095 x 7/8-5/8	0609CZY1-2	\$42.85
7 x .095 x U/A	0709UZY1-2	\$48.20
10 x .095 x U/A	1009UZY1-2	\$93.32



SIZE	PART #	LIST PRICE
4 x .080 x 20mm	0408BDUX4-2	\$40.38
4 x .080 x 7/8-5/8	0408CDUX4-2	\$40.38
4 1/2 x .080 x 20mm	4508BDUX4-2	\$42.54
4 1/2 x .080 x 7/8-5/8	4508CDUX4-2	\$42.54
5 x .080 x 7/8-5/8	0508CDUX4-2	\$49.34
6 x .095 x 7/8-5/8	0609CDUX4-2	\$61.90
6 x .095 x U/A	0609UDUX4-2	\$61.90
7 x .095 x 7/8-5/8	0709CDUX4-2	\$87.86
7 x .095 x U/A	0709UDUX4-2	\$87.86
7 x .125 x 7/8-5/8	0712CDUX4-2	\$114.74
8 x .095 x U/A	0809UDUX4-2	\$96.51
9 x .095 x 7/8-5/8	0909CDUX4-2	\$115.05
9 x .095 x U/A	0909UDUX4-2	\$115.05
10 x .095 x 7/8-5/8	1009CDUX4-2	\$132.66
10 x .095 x U/A	1009UDUX4-2	\$132.66
10 x .125 x 1/20mm	1012EDUX4-2	\$165.11
10 x .187 x 1	1018EDUX4-2	\$212.28
10 x .250 x 1	1025EDUX4-2	\$268.01



SIZE	PART #	LIST PRICE
4 x .080 x 7/8-5/8	0408CDZBY1-2	\$13.70
4 1/2 x .080 x 7/8-5/8	4508CDZBY1-2	\$17.20
5 x .080 x 7/8-5/8	0508CDZBY1-2	\$18.33
7 x .095 x U/A	0709UDZBY1-2	\$34.30
10 x .095 x U/A	1009UDZBY1-2	\$66.33



replaces **ZY1-2**



replaces **X4-2**



replaces **Y1-2**



**X100**  
general purpose 

**VALUE BLADE**  
• 10mm (.394") turbo rim height

**Application(s):**  
• Concrete, Brick, Block



SIZE	PART #	LIST PRICE
4 x .080 x 7/8-5/8	0408CDZBX0-2	\$14.94
4 1/2 x .080 x 7/8-5/8	4508CDZBX0-2	\$18.75
5 x .080 x 7/8-5/8	0508CDZBX0-2	\$20.09
6 x .095 x U/A	0609UDZBX0-2	\$30.80
7 x .095 x DM-5/8	0709DDZBX0-2	\$37.49
7 x .095 x U/A	0709UDZBX0-2	\$37.49
8 x .095 x DM-5/8	0809DDZBX0-2	\$54.28
8 x .095 x U/A	0809UDZBX0-2	\$54.28
9 x .095 x U/A	0909UDZBX0-2	\$70.35
10 x .095 x 7/8-5/8	1009CDZBX0-2	\$72.58
10 x .095 x DM-5/8	1009DDZBX0-2	\$72.58



replaces **X0-2 TURBO**



**X200**  
general purpose 

**HEAVY DUTY BLADE**  
• 10mm (.394") turbo rim height

**Application(s):**  
• Concrete, Brick, Block



SIZE	PART #	LIST PRICE
4 x .080 x 7/8-5/8	0408CDZBX2-2	\$46.97
4 1/2 x .080 x 7/8-5/8	4508CDZBX2-2	\$50.03
5 x .080 x 7/8-5/8	0508CDZBX2-2	\$56.14
6 x .095 x 7/8-5/8	0609CDZBX2-2	\$73.54
7 x .095 x DM-5/8	0709DDZBX2-2	\$76.53
7 x .095 x U/A	0709UDZBX2-2	\$76.53
8 x .095 x U/A	0809UDZBX2-2	\$97.03
9 x .095 x DM-5/8	0909DDZBX2-2	\$131.74
10 x .095 x U/A	1009UDZBX2-2	\$155.22



replaces **X2-2 TURBO**



**X400 VORTEX**  
general purpose 

**SUPREME BLADE**  
• 9mm (.354") turbo rim height

**Application(s)**  
• Concrete, Concrete Pavers, Brick/Block



SIZE	PART #	LIST PRICE
4 x .080 x 7/8-5/8	0408CDZBX4-2	\$66.74
4 1/2 x .080 x 7/8-5/8	4508CDZBX4-2	\$74.98
5 x .080 x 7/8-5/8	0508CDZBX4-2	\$79.62
6 x .095 x 7/8-5/8	0609CDZBX4-2	\$101.56
6 x .095 x U/A	0609UDZBX4-2	\$101.56
7 x .095 x U/A	0709UDZBX4-2	\$122.57
8 x .095 x U/A	0809UDZBX4-2	\$134.52
9 x .095 x 7/8-5/8	0909CDZBX4-2	\$164.70
10 x .095 x U/A	1009UDZBX4-2	\$192.10



replaces **X4-2 VORTEX**



**X400**

segmented abrasives

**SUPREME BLADE**

- 10mm (.394") segment height

**Application(s)**

- Asphalt, Green Concrete, Abrasive Materials



SIZE	PART #	LIST PRICE
4 x .080 x 7/8-5/8	0408CDUX4-4	\$39.66
5 x .095 x 7/8-5/8	0508CDUX4-4	\$48.00
6 x .095 x U/A	0609UDUX4-4	\$60.67
7 x .095 x U/A	0709UDUX4-4	\$87.34
8 x .095 x 7/8-5/8	0809CDUX4-4	\$98.88
8 x .095 x U/A	0809UDUX4-4	\$98.88
8 x .125 x 1/20mm	0812EDUX4-4	\$134.00
9 x .095 x 7/8-5/8	0909CDUX4-4	\$112.79
10 x .095 x 7/8-5/8	1009CDUX4-4	\$130.09
10 x .095 x DM-5/8	1009DDUX4-4	\$129.68
10 x .095 x U/A	1009UDUX4-4	\$129.68
10 x .125 x 1/20mm	1012EDUX4-4	\$182.21



replaces X4-4 VORTEX



**X400 VORTEX**

turbo abrasives

**SUPREME BLADE**

- 9mm (.354") segment height

**Application(s)**

- Abrasive, Green Concrete



SIZE	PART #	LIST PRICE
4 x .080 x 7/8-5/8	0408CDZBX4-4	\$66.74
4 1/2 x .080 x 7/8-5/8	4508CDZBX4-4	\$74.98
5 x .080 x 7/8-5/8	0508CDZBX4-4	\$79.62
6 x .095 x 7/8-5/8	0609CDZBX4-4	\$101.56
6 x .095 x U/A	0609UDZBX4-4	\$101.56
7 x .095 x U/A	0709UDZBX4-4	\$122.57
8 x .095 x U/A	0809UDZBX4-4	\$134.52
9 x .095 x 7/8-5/8	0909UDZBX4-4	\$164.70
10 x .095 x U/A	1009UDZBX4-4	\$192.10

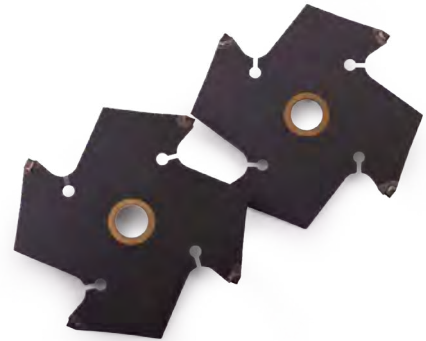

**PCD CUTTER**

- PCD Segment

**Application(s):**

- Removing Caulking Or Joint Sealant
- Compound From Concrete And Masonry Joints



SIZE	PART #	LIST PRICE
4 1/2 x 7/8-5/8, 4 ea	4506PCPD	\$184.99
6 x 7/8-5/8, 6 ea	0606PCPD	\$294.27
7 x U/A, 7 ea	0709UPCD	\$336.30
12 x 1"-20mm, 12ea	1212EPCD	\$538.18
14 x 1"-20mm, 14ea	1412EPCD	\$655.80



**FLUSH CUT ADAPTER**

This adapter is a game changer in the world of diamond blades. For any small diameter blade with flush mount hole pattern. Allows flush cutting and deeper penetration with the blade. Easier for changing tools too as blade is now just spin on and spin off. No more locking nuts!

SIZE	PART #	LIST PRICE
4 Screw to 5/8"-11	FCA	\$23.32





# TUCK POINT CRACK CHASER



**ES100**  
tuck point



**ES110**  
tuck point



**X100**  
tuck point

**ECONOMY BLADE**

- 10mm (.394") segment height
- Sintered

**Application(s):**

- Mortar, Brick, Block, Concrete



SIZE	PART #	LIST PRICE
4 x .250 x 7/8-5/8	0425CDPX0-1	\$37.80
4 1/2 x .250 x 7/8-5/8	4525CDPX0-1	\$41.82
5 x .250 x 7/8-5/8	0525CDPX0-1	\$52.12
7 x .250 x 7/8-5/8	0725CDPX0-1	\$96.00



replaces **XO**

**ECONOMY BLADE**

- 10mm (.394") segment height
- Punch hole core
- Sintered

**Application(s):**

- Mortar, Brick, Block, Concrete



SIZE	PART #	LIST PRICE
4 x .250 x 7/8-5/8	0425CDPX0-1T	\$51.05
4 1/2 x .250 x 7/8-5/8	4525CDPX0-1T	\$61.26
5 x .250 x 7/8-5/8	0525CDPX0-1T	\$71.47
7 x .250 x 7/8-5/8	0725CDPX0-1T	\$112.31



**VALUE BLADE**

- 10mm (.394") segment height

**Application(s):**

- Mortar, Brick, Block, Concrete

SIZE	PART #	LIST PRICE
4 x .250 x 7/8-5/8	0425CDPX1-1T	\$42.85
4 1/2 x .250 x 7/8-5/8	4525CDPX1-1T	\$51.09
5 x .250 x 7/8-5/8	0525CDPX1-1T	\$64.38



replaces **X1-1T**



**X200**  
tuck point



**HEAVY DUTY BLADE**  
 • 10mm (.394") segment height  
  
**Application(s):**  
 • Mortar, Brick, Block, Concrete



SIZE	PART #	LIST PRICE
3 x .250 x 7/8-5/8	0325CDPX2-1	\$51.09
4 x .250 x 7/8-5/8	0425CDPX2-1	\$65.30
4 x .500 x 7/8-5/8	0450CDPX2-1	\$142.96
4 1/2 x .250 x 7/8-5/8	4525CDPX2-1	\$70.45
5 x .250 x 7/8-5/8	0525CDPX2-1	\$81.68
6 x .250 x 7/8-5/8	0625CDPX2-1	\$102.07
7 x .250 x 7/8-5/8	0725CDPX2-1	\$138.84



replaces **X2-1**



**ES100**  
double tuck point



**ECONOMY BLADE**  
 • 10mm (.394") segment height  
 • Sintered  
 • Sandwich double blade  
  
**Application(s):**  
 • Mortar, Brick, Block, Concrete



SIZE	PART #	LIST PRICE
4 x .250 x 7/8-5/8	0408CDBX1	\$54.08
4 1/2 x .250 x 7/8-5/8	4508CDBX1	\$57.17
5 x .250 x 7/8-5/8	0508CDBX1	\$64.27



replaces **DOUBLE TUCK POINT**



**X200**  
double tuck point



**HEAVY DUTY BLADE**  
 • 10mm (.394") segment height  
 • Laser welded blade  
 • Sandwich double blade  
  
**Application(s):**  
 • Mortar, Brick, Block, Concrete



SIZE	PART #	LIST PRICE
4 x .250 x 7/8-5/8	0408CDBX2	\$80.55
4 1/2 x .250 x 7/8-5/8	4508CDBX2	\$84.15
5 x .250 x 7/8-5/8	0508CDBX2	\$102.49
7 x .250 x 7/8-5/8	0709CDBX2	\$182.93



replaces **DOUBLE TUCK POINT**



**X300**  
crack chaser



**PREMIUM BLADE**

- 12.7mm (.500") segment height
- V-shape segments

**Application(s):**

- Concrete, Asphalt



SIZE	PART #	LIST PRICE
4 x .375 x 7/8-5/8	0401CCV	\$139.98
4 x .375 x 5/8-11	0402CCV	\$139.98
4 x .375 x 5/8-11, w/nut	0404CCV	\$139.98
4 x .500 x 7/8-5/8	0450CCV	\$168.30
4 x .500 x 5/8-11 w/nut	0454CCV	\$168.30
4 1/2 x .375 x 7/8-5/8	4501CCV	\$164.70
4 1/2 x .375 x 5/8-11	4504CCV	\$164.70
5 x .375 x 7/8-5/8	0501CCV	\$173.86
5 x .500 x 7/8-5/8	0550CCV	\$249.78
7 x .375 x 7/8-5/8	0701CCV	\$276.25
7 x .375 x 5/8-11, w/nut	0704CCV	\$276.25
7 x .500 x 7/8-5/8	0750CCV	\$332.07
8 x .375 x 7/8-5/8	0801CCV	\$315.59
8 x .375 x 1	0802CCV	\$315.59
8 x .500 x 7/8-5/8	0850CCV	\$375.95
8 x .500 x 1	0850ECCV	\$375.95



replaces **V-SHAPE CRACK CHASER**

X400 (Supreme)  
General Purpose Tile

max 6,100 r.p.m.  
Wet Use Only

**ZENESIS**<sup>®</sup>  
PATTERNED DIAMOND CONTINUOUS RIM BLADE

10"

**TILE  
BLADES**

### TILE BLADE PERFORMANCE CHART





**X100**  
ceramic



**VALUE BLADE**

- Not for extremely hard tile applications
- 10mm (.394") continuous rim height, for longer life
- Clean, chip free cuts on natural stone
- Great value and performance.
- **Do not use for radius cutting.**

**Application(s)**

- Ceramic Tile, Saltillo Tile, Natural Stone Tiles



SIZE	PART #	LIST PRICE
4 x .060 x 5/8	0406ATWX1	\$27.40
4 x .060 x 7/8-5/8	0406CTWX1	\$27.40
4 1/2 x .060 x 5/8	4506ATWX1	\$32.96
4 1/2 x .060 x 7/8-5/8	4506CTWX1	\$32.96
5 x .060 x 5/8	0506ATWX1	\$38.42
5 x .060 x 7/8-5/8	0506CTWX1	\$38.42
6 x .060 x 5/8	0606ATWX1	\$45.73
6 x .060 x 7/8-5/8	0606CTWX1	\$45.73
7 x .060 x 5/8	0706ATWX1	\$50.26
7 x .060 x 7/8-5/8	0706CTWX1	\$50.26
8 x .060 x 5/8	0806ATWX1	\$52.12
10 x .060 x 5/8	1006ATWX1	\$72.31
10 x .060 x 7/8-5/8	1006CTWX1	\$72.31
12 x .080 x 1	1208ETWX1	\$126.28
14 x .080 x 1	1408ETWX1	\$141.83



replaces **X1**



**X300**  
ceramic



**PREMIUM BLADE**

- Not for extremely hard tile applications
- 7.5mm (.295") continuous rim height
- Designed for the professional tile setter
- Super clean chip free cuts on ceramic tile, Saltillo tile and natural stone
- **Do not use for radius cutting.**

**Application(s)**

- Ceramic Tile, Saltillo Tile, Natural Stone Tiles



SIZE	PART #	LIST PRICE
4 x .060 x 5/8	0406ATWX3	\$34.81
4 x .060 x 7/8-5/8	0406CTWX3	\$34.81
4 1/2 x .060 x 5/8	4506ATWX3	\$38.42
5 x .060 x 7/8-5/8	0506CTWX3	\$43.93
6 x .060 x 5/8	0606ATWX3	\$49.44
6 x .060 x 7/8-5/8	0606CTWX3	\$49.44
7 x .060 x 5/8	0706ATWX3	\$53.05
7 x .060 x 7/8-5/8	0706CTWX3	\$53.05
8 x .060 x 5/8	0806ATWX3	\$58.50
8 x .060 x 7/8-5/8	0806CTWX3	\$58.50
10 x .060 x 5/8	1006ATWX3	\$79.62
10 x .060 x 7/8-5/8	1006CTWX3	\$79.62
10 x .060 x 1	1006ETWX3	\$79.62
12 x .080 x 1	1208ETWX3	\$145.44
14 x .080 x 1	1408ETWX3	\$166.45



replaces **X3**



**X400**  
ceramic



**SUPREME BLADE**

- 10mm (.394") continuous rim height, for unbelievable long life.
- For general purpose tile applications
- Premium grade diamonds and technology make this the best ceramic blade on the market.
- **Do not use for radius cutting.**

**Application(s)**

- Ceramic Tile, Saltillo Tile, Natural Stone Tiles



SIZE	PART #	LIST PRICE
4 x .060 x 5/8	0406ATWX4	\$40.27
4 x .060 x 7/8-5/8	0406CTWX4	\$40.27
4 1/2 x .060 x 5/8	4506ATWX4	\$54.90
4 1/2 x .060 x 7/8-5/8	4506CTWX4	\$54.90
5 x .060 x 7/8-5/8	0506CTWX4	\$56.70
6 x .060 x 5/8	0606ATWX4	\$58.50
6 x .060 x 7/8-5/8	0606CTWX4	\$58.50
7 x .060 x 5/8	0706ATWX4	\$64.99
7 x .060 x DM-5/8	0706DTWX4	\$64.99
8 x .060 x 5/8	0806ATWX4	\$70.45
8 x .060 x DM-5/8	0806DTWX4	\$70.45
10 x .060 x 5/8	1006ATWX4	\$91.46
10 x .060 x 1	1006ETWX4	\$91.46
12 x .080 x 1	1208ETWX4	\$158.31
14 x .080 x 1	1408ETWX4	\$178.40



replaces **X4**



**X300**  
porcelain (wet) 

**PREMIUM BLADE**

- 10mm (.394") continuous rim height
- Designed for the harder and thicker porcelains now on the market.
- **Do not use for radius cutting.**

**Application(s)**

- Traditional Porcelain Tile, Large Format Porcelain Tile, Porcelain Outdoor Pavers, Granite Tile



SIZE	PART #	LIST PRICE
4 x .060 x 5/8	0406APWX3	\$51.19
6 x .060 x 5/8	0606APWX3	\$73.23
7 x .060 x 5/8	0706APWX3	\$79.62
8 x .060 x 5/8	0806APWX3	\$100.54
8 x .080 x 5/8	0808APWX3	\$115.26
9 x .060 x 5/8	0906APWX3	\$107.94
10 x .060 x 5/8	1006APWX3	\$112.48
10 x .080 x 5/8	1008APWX3	\$150.07
10 x .080 x 7/8-5/8	1008CPWX3	\$150.07
12 x .080 x 1	1208EPWX3	\$211.36
14 x .080 x 1	1408EPWX3	\$211.36



replaces **X3**



**X400 MUSIC SLOT**  
porcelain (wet) 

**SUPREME BLADE**

- 10mm (.394") continuous rim height, incredible long life for the hardest porcelain.
- **Do not use for radius cutting.**

**Application(s)**

- Pool Tile, Large Format Porcelain, Porcelain Pavers, Granite



SIZE	PART #	LIST PRICE
4 x .060 x 5/8	0406APWX4	\$54.08
7 x .060 x 5/8	0706APWX4	\$83.22
8 x .060 x 5/8	0806APWX4	\$90.54
10 x .060 x 5/8	1006APWX4	\$118.04
12 x .060 x 50/60mm	1206LPWX4	\$219.60
14 x .060 x 50/60mm	1406LPWX4	\$233.30



replaces **X4 MUSIC SLOT**



**ZENESIS™ PORCELAIN**  
hard materials 

**ZENESIS™ BLADE**

- ZENESIS™ PORCELAIN Tile Blade is designed for professionals looking for fast, smooth and chip free cuts on ceramic and all types of porcelain, including large porcelain sheets and porcelain pavers. The continuous rim minimizes chipping and reduces the risk of blade flexing and segment loss.
- 10mm segment height for long life
- **Wet cut only.**
- **Do not use for radius cutting.**



SIZE	PART #	LIST PRICE
4 x .060 x 7/8-5/8 + 20mm	S-0406CWPZ	\$48.05
4 1/2 x .060 x 7/8-5/8 + 20mm	S-4506CWPZ	\$55.25
7 x .060 x 5/8	S-0709AWPZ	\$91.29
10 x .060 x 5/8	S-1006AWPZ	\$127.33





**ZENESIS™**  
hard materials (wet/dry)



**X300**  
glass (wet)



**ZENESIS™ GLASS**  
glass (wet)

**ZENESIS™ BLADE**

- Unique slot and rim design give the **ZENESIS™ Continuous Rim Blade** unparalleled cutting precision and performance, all without breaking a sweat. And since the blade incorporates ZENESIS™ pattern technology, fabricators can count on exceptionally smooth, chip-free cutting of porcelain tile, granite and other hard materials.
- Pool Tile, Large Format Porcelain, Porcelain Pavers, Stone
- Use 4", 4.5", 5" and 6" wet or dry. All other sizes must be used wet.
- **Do not use for radius cutting.**



**PREMIUM BLADE**

- 7.5mm (.295") continuous rim height
- High concentration of fine, top quality diamonds give the smoothest cut of any blade we offer. Badly chipped glass tiles are never acceptable. The solution is here.
- **Wet cut only.**
- **Do not use for radius cutting.**

**Application(s)**

- Glass Tile, Glass Block, Soft Brittle Marble



**ZENESIS™ BLADE**

- The new ZENESIS™ GLASS Tile Blades provide chip-free performance significantly beyond anything currently available on the market. Independent testing has shown this blade to provide superior performance on all types and thicknesses of glass.
- Also provides smooth clean cuts on hard porcelain
- 7.5mm segment height for long life
- **Wet cut only.**
- **Do not use for radius cutting.**

**Application(s)**

- Glass Tile, Glass Block, Soft Brittle Marble



SIZE	PART #	LIST PRICE
4 x .060 x 7/8-5/8 + 20mm	S-0406CTZ	\$40.36
4½ x .060 x 7/8-5/8 + 20mm	S-4506CTZ	\$42.04
5 x .060 x 7/8-5/8 + 20mm	S-0506CTZ	\$48.77
6 x .060 x 7/8-5/8 + 20mm	S-0606CTZ	\$59.70
7 x .060 x U/A	S-0706UTZ	\$70.63
8 x .060 x 1-5/8	S-0806ETZ	\$75.67
8 x .060 x U/A	S-0806UTZ	\$75.67
10 x .080 x 1-5/8	S-1008ETZ	\$118.55
12 x .080 x 1-5/8	S-1208ETZ	\$175.73
12 x .080 x 50/60mm	S-1208TTZ	\$175.73
14 x .080 x 1-5/8	S-1408ETZ	\$195.07
14 x .080 x 50/60mm	S-1408TTZ	\$195.07

SIZE	PART #	LIST PRICE
4 x .060 x 5/8	0405AGWX3	\$77.77
5 x .060 x 5/8	0505AGWX3	\$100.63
5 x .060 x 7/8-5/8	0505CGWX3	\$100.63
7 x .060 x 5/8	0705AGWX3	\$128.03
8 x .060 x 5/8	0805AGWX3	\$136.27
10 x .060 x 5/8	1005AGWX3	\$170.16
12 x .080 x 1	1208EGWX3	\$288.19
14 x .080 x 1	1408EGWX3	\$399.74

SIZE	PART #	LIST PRICE
4 x .060 x 7/8-5/8 + 20mm	S-0406CWGZ	\$45.64
4½ x .060 x 7/8-5/8 + 20mm	S-4506CWGZ	\$50.45
7 x .060 x 5/8	S-0706AWGZ	\$84.08
10 x .060 x 5/8	S-1006AWGZ	\$136.93



replaces **X3**



**X300 THIN T-SLOT**

porcelain (dry)



**PREMIUM BLADE**

- 7.5mm (.295") continuous rim height
- Great for chip free cuts on all tiles and natural stone.
- Designed for small hand held machines to run dry at high RPMs.
- Large circular laser cut outs help to keep blade from overheating.
- **Not recommended for radius cutting.**

**Application(s)**

- All Types of Tile, All Types of Natural Stone

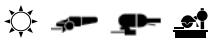

SIZE	PART #	LIST PRICE
4 x .060 x 5/8"	0406APDX3	\$43.67
4 1/2 x .060 x 5/8"	4506APDX3	\$46.45
5" x .060 x 5/8"	0506APDX3	\$51.40
6 x .060 x 5/8"	0606APDX3	\$57.27



replaces **X1-1**



**X401 THIN TURBO**

porcelain (dry)



**SUPREME BLADE**

- 10mm (.394") continuous rim height
- This blade is the go-to for just about everything. Cuts the hardest tiles and stone. Our testing on 3/4" porcelain pavers proved this blade to be the best against all our competitors' porcelain blades. The clean cuts from the unique thin turbo rim design will surprise you.
- **Not recommended for radius cutting.**

**Application(s)**

- Porcelain Tile, Ceramic Tile, Porcelain Pavers



SIZE	PART #	LIST PRICE
4 x .050 x 7/8-5/8"	0406C2PDX4	\$52.85
4 1/2 x .050 x 7/8-5/8"	4506C2PDX4	\$64.38
5 x .050 x 7/8-5/8"	0506C2PDX4	\$69.73
6 x .050 x 7/8-5/8"	0606C2PDX4	\$81.68
7 X .079 x 7/8-5/8"	0708C2PDX4	\$122.52
10 X .079 x 7/8-5/8"	1008A2PDX4	\$192.19
12 X .087 X 1	1209E2PDX4	\$259.46
14 X .087 X 1	1409E2PDX4	\$288.28



replaces **X4**



**Y100**

general purpose (dry)



**QUALITY BLADE**

- 7mm (.284") continuous rim height
- 2x times taller rim than most dry tile blades
- Good for a variety of materials like ceramic tile, Saltillo tile and Cantera stone.
- **Not recommended for radius cutting.**

**Application(s)**

- Ceramic Tile, Exterior Stone, Saltillo Tile, Cantera Stone, Travertine



SIZE	PART #	LIST PRICE
4 x .080 x 7/8-5/8"	0406CTDY2	\$13.49
4 1/2 x .080 x 7/8-5/8"	4506CTDY2	\$14.21
7 x .090 x 5/8"	0706ATDY2	\$28.84
10 x .090 x 5/8"	1006ATDY2	\$46.45



replaces **Y2 (DRY)**



**X300**

general purpose (dry) 

**PREMIUM BLADE**

- 7.5mm (.284") continuous rim height
- This professional grade continuous rim blade uses the most current technology to cut the hardest materials chip free without water.
- Available in sizes 4" to 14".
- **Not recommended for radius cutting.**

**Application(s):**

- Porcelain Tile, Ceramic Tile

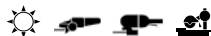

SIZE	PART #	LIST PRICE
4 x .060 x 5/8	0406ATDX3	\$49.03
4 x .060 x 7/8-5/8	0406CTDX3	\$49.03
4 1/2 x .060 x 5/8	4506ATDX3	\$47.59
4 1/2 x .060 x 7/8-5/8	4506CTDX3	\$53.05
5 x .060 x 7/8-5/8	0506CTDX3	\$58.20
6 x .060 x 5/8	0606ATDX3	\$65.82
7 x .060 x 7/8-5/8	0706CTDX3	\$80.65
7 x .060 x DM-5/8	0706DTRDX3	\$80.65
8 x .060 x 5/8	0806ATDX3	\$81.37
8 x .060 x DM-5/8	0806DTRDX3	\$81.37
10 x .060 x 5/8	1006ATDX3	\$104.34
10 x .060 x 7/8-5/8	1006CTDX3	\$104.34
12 x .080 x 1	1208ETDX3	\$183.86
14 x .080 x 1	1408ETDX3	\$210.43



replaces X3 (DRY)



**CORE BITS**

turbo rim

**PREMIUM BIT**

- 5.5mm (.216") segment height, will yield maximum number of holes.
- Sizes over 1" equipped with pilot drill
- These premium grade core bits have a male stem to run on any hand drill.
- The turbo rim is designed for fast, clean drilling.

**Application(s)**

- Porcelain Tile, Ceramic Tile, Granite, Marble, Concrete Countertops



w/P.D.

SIZE	PART #	LIST PRICE
1/2 x .080 x 10mm	ST-00508SDTRCB	\$88.13
3/8 x .080 x 10mm	ST-00608SDTRCB	\$91.69
1/4 x .080 x 10mm	ST-00708SDTRCB	\$91.69
7/8 x .080 x 10mm	ST-00808SDTRCB	\$92.56
1 x .080 x 10mm	ST-01008SDTRCB	\$92.56
1 1/8 x .080 x 10mm	ST-01108SDTRCB	\$96.12
1 1/4 x .080 x 10mm	ST-01208SDTRCB	\$96.12
1 1/2 x .080 x 10mm	ST-01308SDTRCB	\$96.12
1 3/4 x .080 x 10mm	ST-01508SDTRCB	\$107.57
1 5/8 x .080 x 10mm	ST-01608SDTRCB	\$111.13
1 3/4 x .080 x 10mm	ST-01708SDTRCB	\$121.72
1 7/8 x .080 x 10mm	ST-01808SDTRCB	\$121.72
2 x .080 x 10mm	ST-02008SDTRCB	\$121.72



**CORE BITS**

turbo rim

**PREMIUM BIT**

- 5.5mm (.216") segment height
- Sizes over 1" equipped with pilot drill
- Same great quality as our turbo tile bits. Designed to run on any grinder or polisher with 5/8-11 male thread.

**Application(s)**

- Porcelain Tile, Ceramic Tile, Granite, Marble, Concrete Countertops



SIZE	PART #	LIST PRICE
1 x .080 x 5/8 -11	ST-01008HDTRCB	\$95.26
1 1/8 x .080 x 5/8 -11	ST-01108HDTRCB	\$96.12
1 1/4 x .080 x 5/8 -11	ST-01208HDTRCB	\$99.58
1 1/2 x .080 x 5/8 -11	ST-01308HDTRCB	\$99.58
1 3/4 x .080 x 5/8 -11	ST-01508HDTRCB	\$110.16
1 7/8 x .080 x 5/8 -11	ST-01708HDTRCB	\$125.17
2 x .080 x 5/8 -11	ST-02008HDTRCB	\$125.17



# STONE PRODUCTS



**X100-15MM**  
bridge saw blades



**X300-15MM**  
bridge saw blades



**X300-20MM**  
bridge saw blades

**VALUE BLADE**

- Patterned segments allows for maximum performance
- 15mm (.591") segment height
- Silent core for indoor use

**Application(s)**

- Granite, Engineered stone



SIZE	PART #	LIST PRICE
14 X .125 X 50/60mm	S-1412LWGX1-1S15	\$499.45
16 X .125 X 50/60mm	S-1612LWGX1-1S15	\$582.68
18 X .125 X 50/60mm	S-1812LWGX1-1S15	\$853.43

**PREMIUM BLADE**

- 15mm (.591") segment height
- Silent core for indoor use

**Application(s)**

- Granite, Engineered Stone



SIZE	PART #	LIST PRICE
14 x .125 x 50/60mm	S-1412LWGX3-1S15	\$612.62
16 x .125 x 50/60mm	S-1612LWGX3-1S15	\$707.80
18 x .125 x 50/60mm	S-1812LWGX3-1S15	\$886.47

**PREMIUM BLADE**

- 20mm (.787) segment height
- Silent core for indoor use

**Application(s)**

- Granite, Engineered Stone



SIZE	PART #	LIST PRICE
14 x .125 x 50/60mm	S-1412LWGX3-1S20	\$687.70
16 x .125 x 50/60mm	S-1612LWGX3-1S20	\$793.65
18 x .125 x 50/60mm	S-1812LWGX3-1S20	\$992.50



**X400-20MM**  
bridge saw blades 

**SUPREME BLADE**

- Pattern diamond technology guarantee maximum performance start to finish
- 20mm (.787) segment height
- Silent core for indoor use
- Proprietary recipe bond that cuts the hardest natural stone, including quartzite, and engineered stone effortlessly
- Excellent miter cutting blade
- Slanted gullets draw in more water to keep blade running cooler

**Application(s)**

- Granite, Quartzite, Engineered Stone



SIZE	PART #	LIST PRICE
12 x .125 x 50/60mm	S-1212LWPX4-20	\$638.18
14 x .125 x 50/60mm	S-1412LWPX4-20	\$719.74
16 x .125 x 50/60mm	S-1612LWPX4-20	\$836.61
18 x .140 x 50/60mm	S-1814LWPX4-20	\$1,102.31
20 x .140 x 50/60mm	S-2014LWPX4-20	\$1,372.21



**X300-10MM**  
bridge saw blades 

**PREMIUM BLADE**

- 10mm (.394") segment height - have less chance of "flexing" while miter cutting
- Silent core for indoor use
- Clean Cutting
- Smaller diamond particulate gives blade perfect chip free cuts in soft materials like marble and limestone
- Highest diamond concentrate of all our bridge saw blades

**Application(s)**

- Marble



SIZE	PART #	LIST PRICE
12 x .125 x 50/60mm	S-1212LWMS	\$503.16
14 x .125 x 50/60mm	S-1412LWMS	\$594.62
16 x .125 x 50/60mm	S-1612LWMS	\$686.08
18 x .120 x 50/60mm	S-1812LWMS	\$945.95
20 x .140 x 50/60mm	S-2014LWMS	\$1,171.83

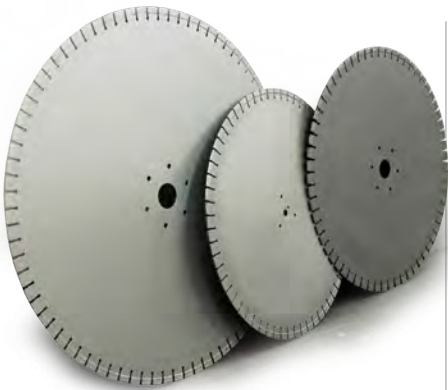

**THIN VENEER**  
large diameter blade

The large diameter blades for thin veneer stone from Diamond Vantage are designed to fit the thin veneer saws. The tall 20mm segments ensure consistent performance and long blade life, increasing your productivity by reducing machine downtime.

- Additional sizes/arbor available upon request.
- Custom Arbor for Park Industries TXS Series\*
- Different bonds available for different types of stone

**Application(s)**

- Thin Veneer

SIZE	PART #	LIST PRICE
36 x .250	S-3625XWX4	\$3,085.88
40 x .250	S-4025XWX4	\$3,447.41
48 x .250	S-4825XWX4	\$4,095.28



**X100**  
turbo rim



**VALUE BLADE**

- 8mm (.315") rim height - for longer life
- 4 countersunk in holes in core to accommodate flush mount adapters, see pg 66 for Flush Cut Adapter
- Fast, clean cuts on hard granite and engineered stone



SIZE	PART #	LIST PRICE
4 x .080 x 7/8-20mm-%	S-0408CDZX1-1	\$25.75
4½ x .080 x 7/8-20mm-%	S-4508CDZX1-1	\$29.66
5 x .080 x 7/8-20mm-%	S-0508CDZX1-1	\$32.03
6 x .095 x 7/8-20mm-%	S-0609CDZX1-1	\$41.30
7 x .095 x U/A	S-0709UDZX1-1	\$51.29



**X200**  
turbo rim



**HEAVY DUTY BLADE**

- 8mm (.315") rim height
- #1 selling blade in stone industry
- Flush mount adapter ready, see pg 66 for Flush Cut Adapter
- Great for granite, engineered stone, flagstone, sandstone and brick pavers



SIZE	PART #	LIST PRICE
4 x .080 x 7/8-20mm-%	S-0408CDZX2-1	\$29.25
4½ x .080 x 7/8-20mm-%	S-4508CDZX2-1	\$32.03
5 x .080 x 7/8-20mm-%	S-0508CDZX2-1	\$36.57
6 x .095 x 7/8-20mm-%	S-0609CDZX2-1	\$44.81
7 x .095 x U/A	S-0709UDZX2-1	\$55.83



replaces **X2-1**



**X400**  
turbo rim



**SUPREME BLADE**

- 8mm (.315") rim height
- Flush mount adapter ready, see pg 66 for Flush Cut Adapter
- Designed for the professional who demands the best quality
- Fast clean cuts in the hardest materials like granite and quartzite



SIZE	PART #	LIST PRICE
4 x .080 x 7/8-20mm-%	S-0408CDZX4-1	\$64.04
4½ x .080 x 7/8-20mm-%	S-4508CDZX4-1	\$64.95
5 x .080 x 7/8-20mm-%	S-0508CDZX4-1	\$73.18
6 x .095 x 7/8-20mm-%	S-0609CDZX4-1	\$102.45
7 x .095 x U/A	S-0709UDZX4-1	\$128.99



replaces **X4-1**



**CONTOUR BLADE**  
segmented

**PREMIUM BLADE**

- Segmented contour blade
- 6.5mm (.255") segment height
- Contoured core for making radius cuts and cutting sink openings
- Unique "T" shaped segments to prevent blade binding while cutting
- Longest lasting
- Soft bond for cutting natural stone and concrete

**Application(s)**

- Granite, Engineered Stone



SIZE	PART #	LIST PRICE
4 x .150 x 7/8-5/8"	S-0415CCS	\$139.98
4 1/2 x .150 x 7/8-5/8"	S-4515CCS	\$144.51
5 x .150 x 7/8-5/8"	S-0515CCS	\$155.53



replaces **CCS**



**CONTOUR BLADE**  
turbo rim

**PREMIUM BLADE**

- Turbo rim contour blade
- 6.5mm (.255") segment height
- Contoured core for making radius cuts and cutting sink openings
- Turbo style rim for fastest cutting
- Undercutting segments to prevent binding while cutting
- Soft bond for cutting natural stone and concrete

**Application(s)**

- All Natural Stone, Engineered Stone



SIZE	PART #	LIST PRICE
4 x .150 x 7/8-5/8"	S-0415CCZ	\$139.98
4 1/2 x .150 x 7/8-5/8"	S-4515CCZ	\$144.51
5 x .150 x 7/8-5/8"	S-0515CCZ	\$155.53



replaces **CCZ**

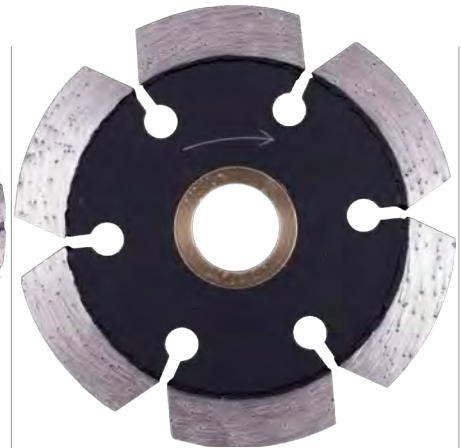

**RODDING BLADE**

**PREMIUM BLADE**

- 10mm (.394") segment height
- Specifically designed for cutting a channel in the underside of countertops
- 3.3" diameter blade - will guarantee not to blow through the surface of the stone
- 1/8" thickness for fish tape and fiberglass rodding material
- 1/4" thickness for thicker rodding material like all-thread
- Proprietary super soft bond for the hardest materials like granite and quartzite

**Application(s)**

- All Natural Stone, Engineered Stone



SIZE	PART #	LIST PRICE
3.3 x 1/8 x 7/8-5/8"	S-3312CRX4-1	\$107.62
3.3 x 1/4 x 7/8-5/8"	S-3325CRX4-1	\$156.40





**ZENESIS™ CORE BITS**  
segmented

**ZENESIS™ BIT**

ZENESIS™ DRY CORE BIT is thoroughly engineered to achieve superior wet and dry coring of granite and engineered stone. Laser-welded segments, enlarged cooling holes, and generous side coating result in faster cleaner cuts without even breaking a sweat.

- Available with 5/8-11 threads
- All-new design for enhanced performance
- Laser-welded segments for safer coring
- Larger cooling holes on the barrel
- Abrasive side coating to reduce friction
- Designed for granite and engineered stone
- Can be used wet or dry



SIZE	PART #	LIST PRICE
1¼ x .125 x 5/8-11	S-01212HDZX4	\$195.92
1½ x .125 x 5/8-11	S-01312HDZX4	\$177.26
1½ x .125 x 5/8-11	S-01512HDZX4	\$198.25
2 x .125 x 5/8-11	S-02012HDZX4	\$200.58
2¼ x .125 x 5/8-11	S-02212HDZX4	\$244.90
2½ x .125 x 5/8-11	S-02512HDZX4	\$240.23
3 x .125 x 5/8-11	S-03012HDZX4	\$300.87



**RED CORE BITS**  
segmented

**PREMIUM BIT**

- Available with 5/8-11 threads
- For drilling of granite and engineered stone
- Equipped with side plating (faster drilling)



SIZE	PART #	LIST PRICE
1 x .125 x 5/8-11	S-01012HDSBSL	\$129.01
1½ x .125 x 5/8-11	S-01112HDSBSL	\$133.36
1½ x .125 x 5/8-11	S-01212HDSBSL	\$136.86
1¾ x .125 x 5/8-11	S-01312HDSBSL	\$136.86
1½ x .125 x 5/8-11	S-01512HDSBSL	\$144.60
1¾ x .125 x 5/8-11	S-01712HDSBSL	\$163.70
2 x .125 x 5/8-11	S-02012HDSBSL	\$169.74



**BLACK CORE BITS**  
segmented

**SUPREME BIT**

- Available with 5/8-11 threads
- For drilling of granite and engineered stone
- Equipped with side plating (longer drilling)



SIZE	PART #	LIST PRICE
1 x .125 x 5/8-11	S-01012HDSBSLX4	\$129.01
1¼ x .125 x 5/8-11	S-01212HDSBSLX4	\$129.11
1½ x .125 x 5/8-11	S-01312HDSBSLX4	\$136.86
1½ x .125 x 5/8-11	S-01512HDSBSLX4	\$144.60
1¾ x .125 x 5/8-11	S-01712HDSBSLX4	\$163.70
2 x .125 x 5/8-11	S-02012HDSBSLX4	\$169.74
2¼ x .125 x 5/8-11	S-02212HDSBSLX4	\$190.54
2½ x .125 x 5/8-11	S-02512HDSBSLX4	\$212.18
3 x .125 x 5/8-11	S-03012HDSBSLX4	\$229.47



**WET THIN WALL  
CORE BITS (5/8-11)**

**PREMIUM BIT**

- 9.5mm (.374") segment height

**Application(s)**

- All Natural Stone



SIZE	PART #	LIST PRICE
3/4 x 5/8-11 (19mm)	S-00712HTWCB	\$105.30
1 x 5/8-11 (25mm)	S-01012HTWCB	\$111.00
1 1/8 x 5/8-11 (28mm)	S-01112HTWCB	\$114.30
1 1/4 x 5/8-11 (32mm)	S-01212HTWCB	\$118.40
1 3/8 x 5/8-11 (35mm)	S-01312HTWCB	\$124.10
1 1/2 x 5/8-11 (38mm)	S-01512HTWCB	\$129.00
1 3/4 x 5/8-11 (44mm)	S-01712HTWCB	\$142.90
2 x 5/8-11 (51mm)	S-02012HTWCB	\$164.90
2 1/8 x 5/8-11 (60mm)	S-02312HTWCB	\$176.30
2 1/4 x 5/8-11 (67mm)	S-02612HTWCB	\$198.40
3 x 5/8-11 (75mm)	S-03012HTWCB	\$218.00
4 x 5/8-11 (100mm)	S-04012HTWCB	\$308.60
4 1/4 x 5/8-11 (120mm)	S-04712HTWCB	\$367.40



**WET THIN WALL  
CORE BITS (GAS THREAD)**

**PREMIUM BIT**

- 8.5mm (.374") segment height

**Application(s)**

- All Natural Stone



SIZE	PART #	LIST PRICE
1 x 1/2 Gas (25mm)	S-01012GTWCB	\$111.00
1 1/4 x 1/2 Gas (32mm)	S-01212GTWCB	\$118.40
1 3/8 x 1/2 Gas (35mm)	S-01312GTWCB	\$124.10
1 1/2 x 1/2 Gas (38mm)	S-01512GTWCB	\$129.00
2 x 1/2 Gas (51mm)	S-02012GTWCB	\$164.90



**NON-CORING BITS**

**PREMIUM BIT**

- 7mm (.275") segment height

**Application(s)**

- All Natural Stone



SIZE	PART #	LIST PRICE
3/16 x 5/8-11	NCB18	\$84.08
1/4 x 5/8-11	NCB25	\$88.28
3/8 x 5/8-11	NCB37	\$91.65
1/2 x 5/8-11	NCB50	\$109.30



**GREEN CUP WHEEL**  
flat turbo rim

**PREMIUM CUP WHEEL**

- 10mm (.394") segment height

**Application(s)**

- Granite and All Natural and Engineer Stone



SIZE	PART #	LIST PRICE
6 x 5/8-11, coarse grit	S-06HDZFGX3	\$218.57



**BLUE CUP WHEEL**  
turbo rim

**PREMIUM CUP WHEEL**

- Special turbo design for a fast and smooth finish
- Coarse grit for the most aggressive (fastest) grinding
- Medium grit for a combination of both speed and finish
- Fine grit for the smoothest finish

**Application(s)**

- Granite and All Natural and Engineer Stone



SIZE	PART #	LIST PRICE
4 x 5/8-11, coarse grit	S-04HDZGX3-C	\$134.52
4 x 5/8-11, fine grit	S-04HDZGX3-F	\$134.52
4 x 5/8-11, medium grit	S-04HDZGX3-M	\$134.52
5 x 5/8-11, coarse grit	S-05HDZGX3-C	\$201.78
5 x 5/8-11, fine grit	S-05HDZGX3-F	\$201.78
5 x 5/8-11, medium grit	S-05HDZGX3-M	\$201.78
6 x 5/8-11, coarse grit	S-06HDZGX3-C	\$239.68
6 x 5/8-11, fine grit	S-06HDZGX3-F	\$239.68
6 x 5/8-11, medium grit	S-06HDZGX3-M	\$239.68
7 x 5/8-11, coarse grit	S-07HDZGX3-C	\$290.05
7 x 5/8-11, medium grit	S-07HDZGX3-M	\$290.05



**RESIN CUP WHEEL**  
resin filled

**PREMIUM CUP WHEEL**

- Chip free and vibration free
- Great on beveling
- Resin filled segments create a continuous grinding surface
- Precision balanced for zero vibration
- Smoothest finishing with virtually zero swirl pattern
- Available in coarse, medium and fine
- Best cup for grinding flat surfaces and edges

**Application(s)**

- All Natural and Engineer Stone



SIZE	PART #	LIST PRICE
4 x 5/8-11, coarse	S-04CWRIGGX2-2	134.53
4 x 5/8-11, medium	S-04MWRIGGX2-2	134.53
4 x 5/8-11, fine	S-04FWRIGGX2-2	134.53
4.5 x 5/8-11, coarse	S-45CWRIGGX2-2	160.96
4.5 x 5/8-11, medium	S-45MWRIGGX2-2	160.96
4.5 x 5/8-11, fine	S-45FWRIGGX2-2	160.96



**FLEXIBLE BACKING PADS**  
backing pad

- For attaching velcro-backed polishing pads
- 5/8-11 threading
- Flex type

**Application(s)**

- All Natural Stone



SIZE	PART #	LIST PRICE
3 x 5/8-11	S-3BP	\$20.40
4 x 5/8-11	S-4BP	\$26.90
5 x 5/8-11	S-5BP	\$32.70
7 x 5/8-11	S-7BP	\$107.29

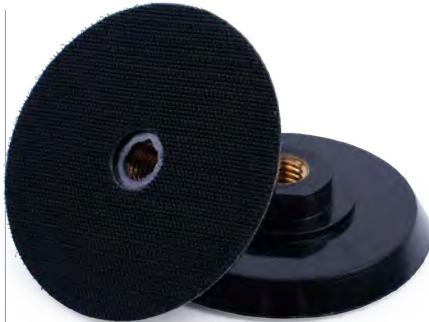

**RIGID BACKING PADS**  
backing pad

For attaching velcro-backed polishing pads

**Application(s)**

- All Natural Stone



SIZE	PART #	LIST PRICE
3 x 5/8-11	S-3BPR	\$29.39
4 x 5/8-11	S-4BPR	\$31.84
5 x 5/8-11	S-5BPR	\$35.10



**DIAMOND HAND PAD**

**PREMIUM PAD**

Our hand polishing pads have so many uses it is almost limitless. Originally designed for doing repairs on stone without power tools. We have also found them to be great for taking off sharp edges on porcelain tile, removing calcium from swimming pool tiles and prepping concrete overlays. Available individually or in sets from 50 – 3000 grit.



SIZE	PART #	LIST PRICE
Electroplated #50	S-HPEL-50	\$69.67
Electroplated #100	S-HPEL-100	\$69.67
Electroplated #200	S-HPEL-200	\$69.67
Electroplated #400	S-HPEL-400	\$69.67
Electroplated #800	S-HPEL-800	\$69.67
Electroplated #1500	S-HPEL-1500	\$69.67
Electroplated #3000	S-HPEL-3000	\$69.67



**CUTTER GRINDER**

- Cut & Grind with one blade
- With or without flush mount adapter, see pg 66 for Flush Cut Adapter
- This unique 2-in-1 blade is the ultimate stone installer's tool
- Cuts and grinds the hardest materials like granite, engineered stone, flagstone and concrete pavers with ease!

**Application(s)**

- All Natural and Engineer Stone



SIZE	PART #	LIST PRICE
4 X .100 X 7/8	0410CZCGX3-2	114.10
4.5 X .100 X 7/8	4510CZCGX3-2	123.01
5 X .100 X 7/8	0510CZCGX3-2	134.95
6 X .100 X 7/8	0610CZCGX3-2	157.73
7 X .100 X 7/8	0710CZCGX3-2	208.36



**PROFILE WHEEL**

general purpose (wet)

**PREMIUM BLADE**

The best and fastest way to bevel or bullnose tile is with our 6" tile saw wheels. This is a professional grade, production tool that can shape marble, ceramic, granite and even the hardest porcelain tiles. Not to be confused with other brands that use electroplated or brazed diamonds, our blades have a metal bond with multiple layers of diamond to outlast all others.



SIZE	PART #	LIST PRICE
6" x .375" x 3/8	S-0637AWPC-B	\$430.01
Demi Bullnose, Shape B		
6" x .500" x 3/8	S-0650AWPC-B	\$480.46
Demi Bullnose, Shape B		
8" x .375" x 3/8	S-0837AWPC-B	\$598.18
Demi Bullnose, Shape B		
8" x .500" x 3/8	S-0850AWPC-B	\$639.02
Demi Bullnose, Shape B		
6" x .375" x 3/8	S-0637AWPC-E	\$561.45
Bevel, Shape E		
6" x .500" x 3/8	S-0650AWPC-E	\$607.79
Bevel, Shape E		
6" x .500" x 3/8	S-0650AWPC-F	\$824.00
Ogee, Shape F		



**ROUTER BIT**

general purpose (wet/dry)

**PREMIUM BIT**

Grinder router bits have a female 5/8" arbor that threads onto any grinder to profile marble, porcelain, block and granite. Each bit has 2 independent steel (not plastic) bearings so they can be run wet or dry. The shaping is done with high quality, large particulate diamonds that are brazed to the body of the bit. Top quality components equal top quality performance!



SIZE	PART #	LIST PRICE
¼ Radius x ¾-11	S-20H3040RB-B	\$588.57
¾ Radius x ¾-11	S-10H3040RB-B	\$454.04
30mm Bullnose x ¾-11	S-30H3040RB-V	\$723.10
½" Bevel x ¾-11	S-15H3040RB-E	\$492.47



**FINGER BITS**

**PREMIUM BIT**

- 6 segments

**Application(s)**

- All Natural Stone



SIZE	PART #	LIST PRICE
22mm OD x 1½ L x ½ Gas	S-02241NWFB	\$227.02
22mm OD x 2 L x ½ Gas	S-02251NWFB	\$231.65
25mm OD x 1½ L x ½ Gas	S-02541NWFB	\$227.02
25mm OD x 2 L x ½ Gas	S-02551NWFB	\$252.25



**ZERO TOLERANCE WHEEL**

**PREMIUM WHEEL**

- Resin filled
- Designed for grinding on vertical surfaces like sink openings
- Resin filled segments for smooth finish great on any natural stone, masonry and concrete
- Available in 2", 3" and 4" diameter.

**Application(s)**

- All Natural Stone



SIZE	PART #	LIST PRICE
Segmented		
2 x 1½ L x ¾-11	S-02158HZT-S	\$218.61
3 x 1½ L x ¾-11	S-03158HZT-S	\$264.85
4 x 1½ L x ¾-11	S-04158HZT-S	\$315.30
Resin Filled		
2 x 1½ L x ¾-11	S-02158HZT-R	\$260.65
3 x 1½ L x ¾-11	S-03158HZT-R	\$311.10
4 x 1½ L x ¾-11	S-04158HZT-R	\$361.55



**VALUE PLUS WET PADS**

wet polishing pads

**STANDARD PADS**

- Wet polishing pads spiral type
- This 2.5mm thick pad gives the best bang for the buck
- Achieves high gloss quickly
- Designed for natural and engineered stone

**Application(s)**

- All Natural Stone



SIZE	PART #	LIST PRICE
4 x 5/8, 50 grit	S-4WPPY-50	\$13.18
4 x 5/8, 100 grit	S-4WPPY-100	\$13.18
4 x 5/8, 200 grit	S-4WPPY-200	\$13.18
4 x 5/8, 400 grit	S-4WPPY-400	\$13.18
4 x 5/8, 800 grit	S-4WPPY-800	\$13.18
4 x 5/8, 1500 grit	S-4WPPY-1500	\$13.18
4 x 5/8, 3000 grit	S-4WPPY-3000	\$13.18
4 x 5/8, black buff	S-4WPPY-B	\$15.88
4 x 5/8, white buff	S-4WPPY-W	\$15.88

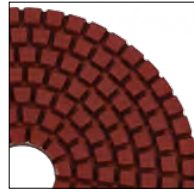

**STANDARD WET PADS**

wet polishing pads

**STANDARD PADS**

- Wet polishing pads, square type
- This 3mm thick pad is our most popular pad
- Available in 3, 4 and 5" diameter
- Excellent for granite, engineered stone and concrete

**Application(s)**

- All Natural Stone



SIZE	PART #	LIST PRICE
3 x 3/4 50 Grit	S-3WPP-50	\$17.60
3 x 3/4 100 Grit	S-3WPP-100	\$17.60
3 x 3/4 200 Grit	S-3WPP-200	\$17.60
3 x 3/4 400 Grit	S-3WPP-400	\$17.60
3 x 3/4 800 Grit	S-3WPP-800	\$17.60
3 x 3/4 1500 Grit	S-3WPP-1500	\$17.60
3 x 3/4 3000 Grit	S-3WPP-3000	\$17.60
4 x 5/8 50 Grit	S-4WPP-50	\$23.76
4 x 5/8 100 Grit	S-4WPP-100	\$23.76
4 x 5/8 200 Grit	S-4WPP-200	\$23.76
4 x 5/8 400 Grit	S-4WPP-400	\$23.76
4 x 5/8 800 Grit	S-4WPP-800	\$23.76
4 x 5/8 1500 Grit	S-4WPP-1500	\$23.76
4 x 5/8 3000 Grit	S-4WPP-3000	\$23.76
5 x 5/8 50 Grit	S-5WPP-50	\$30.89
5 x 5/8 100 Grit	S-5WPP-100	\$30.89
5 x 5/8 200 Grit	S-5WPP-200	\$30.89
5 x 5/8 400 Grit	S-5WPP-400	\$30.89
5 x 5/8 800 Grit	S-5WPP-800	\$30.89
5 x 5/8 1500 Grit	S-5WPP-1500	\$30.89
5 x 5/8 3000 Grit	S-5WPP-3000	\$30.89

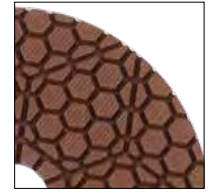

**PREMIUM WET PADS**

wet polishing pads

**PREMIUM PADS**

- Wet polishing pads, beehive type
- Designed for the fabricator who demands the best quality
- Unique honeycomb segments for the best water displacement while polishing
- Highest gloss finish
- 3mm thick pad for long life
- Available in 4 and 5" diameter

**Application(s)**

- All Natural Stone



SIZE	PART #	LIST PRICE
4 x 3/4 50 Grit	S-4WPPX-50	\$32.65
4 x 3/4 100 Grit	S-4WPPX-100	\$32.65
4 x 3/4 200 Grit	S-4WPPX-200	\$32.65
4 x 3/4 400 Grit	S-4WPPX-400	\$32.65
4 x 3/4 800 Grit	S-4WPPX-800	\$32.65
4 x 3/4 1500 Grit	S-4WPPX-1500	\$32.65
4 x 3/4 3000 Grit	S-4WPPX-3000	\$32.65
5 x 3/4 50 Grit	S-5WPPX-50	\$44.90
5 x 3/4 100 Grit	S-5WPPX-100	\$44.90
5 x 3/4 200 Grit	S-5WPPX-200	\$44.90
5 x 3/4 400 Grit	S-5WPPX-400	\$44.90
5 x 3/4 800 Grit	S-5WPPX-800	\$44.90
5 x 3/4 1500 Grit	S-5WPPX-1500	\$44.90
5 x 3/4 3000 Grit	S-5WPPX-3000	\$44.90

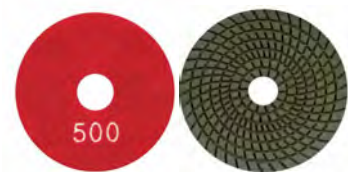

replaces **PREMIUM POLISHING PADS WITH THE SPIRAL SHAPE**

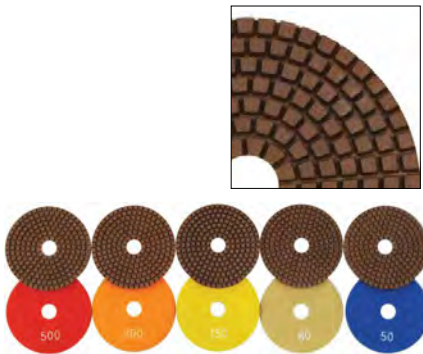

**METAL WET PADS**

metal polishing pads

**PREMIUM PADS**

- Metal polishing pads, square type
- Metal/resin hybrid pad lasts up to 4 times longer than standard resin pads
- More aggressive than standard resin pads
- Best pad for transitioning from grinding to polishing

**Application(s)**

- All Natural Stone



SIZE	PART #	LIST PRICE
4 x 5/8", 50 GRIT	S-4MPP50	\$45.70
4 x 5/8", 80 GRIT	S-4MPP80	\$45.70
4 x 5/8", 150 GRIT	S-4MPP150	\$45.70
4 x 5/8", 300 GRIT	S-4MPP300	\$45.70
4 x 5/8", 500 GRIT	S-4MPP500	\$45.70

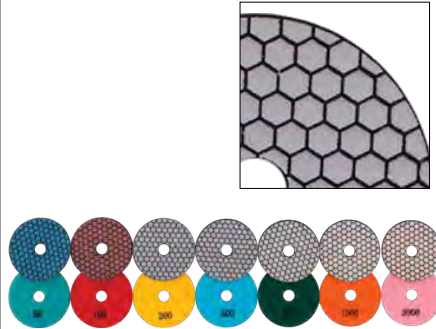

**HEXAGON DRY PADS**

dry polishing pads

**PREMIUM PADS**

- Dry polishing pads, hexagon type

**Application(s)**

- All Natural Stone



SIZE	PART #	LIST PRICE
4 x 5/8", 50GRIT	S-4DPPH50	\$28.60
4 x 5/8", 100GRIT	S-4DPPH100	\$28.60
4 x 5/8", 200 GRIT	S-4DPPH200	\$28.60
4 x 5/8", 400 GRIT	S-4DPPH400	\$28.60
4 x 5/8", 800 GRIT	S-4DPPH800	\$28.60
4 x 5/8", 1500 GRIT	S-4DPPH1500	\$28.60
4 x 5/8", 3000 GRIT	S-4DPPH3000	\$28.60
5 x 5/8", 50 GRIT	S-5DPPH50	\$48.98
5 x 5/8", 100 GRIT	S-5DPPH100	\$48.98
5 x 5/8", 200 GRIT	S-5DPPH200	\$48.98
5 x 5/8", 400 GRIT	S-5DPPH400	\$48.98
5 x 5/8", 800 GRIT	S-5DPPH800	\$48.98
5 x 5/8", 1500 GRIT	S-5DPPH1500	\$48.98
5 x 5/8", 3000 GRIT	S-5DPPH3000	\$48.98



**HYBRID 3 STEP DRY PADS**

dry polishing pads

**PREMIUM PADS**

- Replacing 7-step polishing with only 3 pads
- #1 pad sand the material, removing saw and grinding marks. Perfect for tumbled travertine.
- #2 pad hones the material giving it a semi-gloss look and super smooth finish.
- # 3 pad polishes the material giving it a full gloss shine quickly.
- Great for backsplashes and sink openings.
- Amazing for giving porcelain a finished edge detail.

**Application(s)**

- All Natural Stone

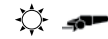

SIZE	PART #	LIST PRICE
4 x 5/8", Pro1	S-4DP-P1	\$20.21
4 x 5/8", Pro2	S-4DP-P2	\$20.21
4 x 5/8", Pro3	S-4DP-P3	\$20.21
4 x 5/8", Pro1, Pro2, Pro3 Set	S-4DP-3STEP	\$60.64





**SHAPING TOOLS**

**PREMIUM SHAPING TOOL**

- Shank size: 5.95mm diameter, 45mm length
- Designed to be used where diamond blades and cup wheels can't
- 1/4" shank to fit any tool with 1/4" collet like die grinders and trim routers
- Extremely popular with stone sculptors

**Application(s)**

- Different shapes available for natural stones and concrete.



SIZE	DIA.(mm)	H.(mm)	PART#	LIST PRICE	SIZE	DIA.(mm)	H.(mm)	PART#	LIST PRICE
FORM 1	25	5	S-ST01	\$71.48	FORM 9	8	16	S-ST09	\$71.48
FORM 2	30	5	S-ST02	\$71.48	FORM 10	12.5	15	S-ST10	\$71.48
FORM 3	30	1.9	S-ST03	\$71.48	FORM 11	10	30	S-ST11	\$71.48
FORM 4	25	6	S-ST04	\$71.48	FORM 12	12	20	S-ST12	\$71.48
FORM 5	30	1.8	S-ST05	\$71.48	FORM 13	13	12.2	S-ST13	\$71.48
FORM 6	16	8.7	S-ST06	\$71.48	FORM 14	12	17	S-ST14	\$71.48
FORM 7	8	6.6	S-ST07	\$71.48	FORM 15	14	12	S-ST15	\$71.48
FORM 8	8	16	S-ST08	\$71.48					

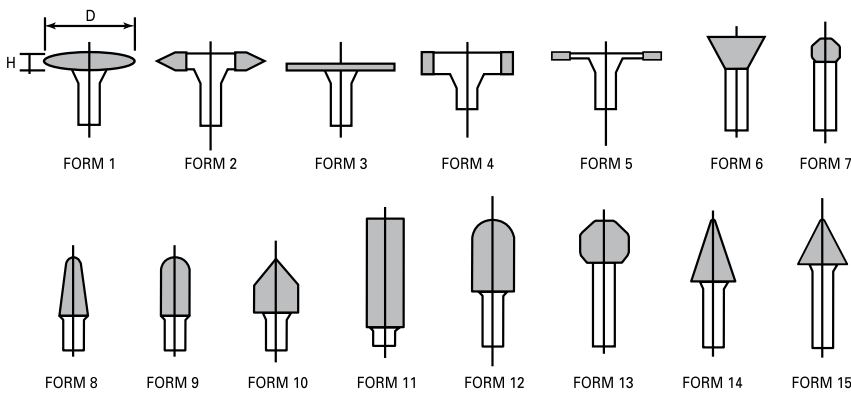



T66997-2  
DXA2730P45H  
MAX RPM 13,600

# METAL CUTTING PRODUCTS

**HIGH PERFORMANCE AND COST EFFICIENCY :**

**LONG TOOL LIFE AND LESS DOWN TIME**  
 DiamondX<sup>®</sup> saves you money by providing extended tool life as well as dramatically reducing downtime caused by changing out worn abrasives.

**SAFETY :**

**REDUCED VIBRATION AND LESS WHEEL BREAKAGE**  
 Traditional bonded abrasives are susceptible to fracture and breakage. If this occurs, it can cause injury and becomes a serious safety concern. DiamondX<sup>®</sup> improved technology of brazing diamond grits to the surface of a solid steel body greatly reduces the risk of fracture and breakage.

**WHEEL WEAR :**

**RETAINS TOOL SIZE AND SHAPE**  
 The disadvantages of traditional bonded abrasives are short tool life and continuously changing tool size and shape during usage. DiamondX<sup>®</sup> offers extended tool life, and its size and shape does not change throughout its tool life.

**APPLICATION :**

**VARIETY AND VERSATILITY**  
 DiamondX<sup>®</sup> offers a wide variety of tools for cutting, grinding, weld joint removal, forming, and surface prep work. And because DiamondX<sup>®</sup> tools are exceptionally versatile, they can be used on ferrous and non-ferrous metals as well as ceramics and polymers.



**ENVIRONMENTALLY AND OPERATOR FRIENDLY :**

**REDUCED SPARKS, LESS DEBRIS AND MINIMAL ODOR**  
 Traditional abrasives produce a high volume of sparks and odor as well as debris as the abrasives wear down. With DiamondX<sup>®</sup>, sparks are greatly reduced, odor is minimal, and the only debris remaining is from the material being worked.

**Reduced Sparks**

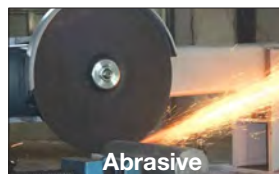

Abrasive



DIAMOND<sup>X</sup>

**Less Debris**

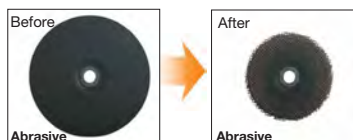

Abrasive

Abrasive

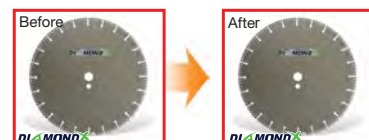

DIAMOND<sup>X</sup>

DIAMOND<sup>X</sup>



**CHOPPER**  
DIAMOND<sup>®</sup>X

The all-new **Diamond<sup>®</sup>X Chopper** is a metal cutting chop saw blade. Designed for use on low-powered metal cutting chop saws, the 14" **Diamond<sup>®</sup>X Chopper** will chop through steel, stainless steel, rebar, structural steel and bolts with ease. The 14" **Diamond<sup>®</sup>X Chopper** will make more cuts than up to 70 conventional abrasive wheels\*, greatly increasing the productivity by reducing the downtime associated with changing out worn abrasives. Like all **Diamond<sup>®</sup>X** products, the new 14" **Diamond<sup>®</sup>X Chopper** is much safer and more eco-friendly than abrasives. The tools are made of steel and diamonds, which retain their shape, cut after cut. The steel core is virtually indestructible, providing a much safer working environment when compared to conventional abrasives that can fracture & break. Sparks, odor and debris are all greatly reduced, improving working conditions for the operator.

\*1 14" **Diamond<sup>®</sup>X Chopper** will outlast up to 70 14" abrasive discs. Results may vary depending on the application, machine, and operator.

**Applications**

Steel, Stainless Steel, Rebar, Studs, Bolts, Pipe, Sectional Tubing & More!



SIZE	PART#	LIST PRICE
14 x .134 x 1/20mm	DXC0120P1413E	\$302.70
RPM 4,300		



**CUTTER**  
DIAMOND<sup>®</sup>X

The all-new 14" **Diamond<sup>®</sup>X Cutter** is the most advanced, versatile and powerful Diamond<sup>®</sup> blade we've ever created. We've made advancements to our brazing technology to increase the speed and longevity of the blade. The higher quality diamonds are bonded to the steel core with a level of precision that is simply unmatched in the industry. Designed for use on high speed gasoline cutoff saws and higher-powered chop saws, the 14" **Diamond<sup>®</sup>X Cutter** will slice through steel, stainless steel, rebar, structural steel and bolts with ease. The 14" **Diamond<sup>®</sup>X Cutter** will make more cuts than up to 70 conventional abrasive wheels\*, greatly increasing the productivity by reducing the downtime associated with changing out worn abrasives. Like all **Diamond<sup>®</sup>X** products, the new 14" **Diamond<sup>®</sup>X Cutter** is much safer and more eco-friendly than abrasives. The tools are made of steel and diamonds, which retain their shape, cut after cut. The steel core is virtually indestructible, providing a much safer working environment when compared to conventional abrasives that can fracture & break. Sparks, odor and debris are all greatly reduced, improving working conditions for the operator.

**For use only on a high speed gas saw**

**Applications**

Steel, Stainless Steel, Bolts, Nonferrous materials, Plastics, Fiberglass, Wood, Concrete, Tile, Brick



SIZE	PART#	LIST PRICE
14 x .150 x 1/20mm	DXH0120P1415E	\$429.65
RPM 5,400		



**CUTTER**  
DIAMOND<sup>®</sup>

**Application(s)**

- Steel, Stainless Steel, Bolts, Nonferrous materials, Plastics, Fiberglass, Wood, Concrete, Tile, Brick



SIZE	PART#	LIST PRICE
2 x .050 x 3/8-1/4	DXE0130P02053	\$39.29
3 x .050 x 3/8-1/4	DXE0130P03053	\$42.91
4 x .050 x 3/8	DXE0130P0405A	\$45.62
4 1/2 x .050 x 3/8	DXE0130P4505C	\$51.31
5 x .050 x 3/8	DXE0130P0505C	\$57.94
6 x .050 x 3/8	DXE0130P0605C	\$67.21
7 x .060 x U/A	DXE0130P0706U	\$86.38
9 x .060 x 3/8	DXE0130P0906C	\$158.48

\*2" through 9" sold in packs of 5

**RPM**

4"	15,300
4.5"	13,600
5"	12,225
6"	10,200
7"	8,600
9"	6,600



**TYPE 29**  
DIAMOND<sup>®</sup>

**Application(s)**

- Weld removal, pipe beveling, and stock removal of all ferrous and non-ferrous metals including mild steel, stainless steel, alloy steels, ductile materials, hard-face metal alloys and ceramic



SIZE	GRIT SIZE	PART #	LIST PRICE
4 x 5/8	24	DXA2920P04A	\$103.72
4 1/2 x 5/8-11	24	DXA2920P45H	\$112.58
5 x 5/8-11	24	DXA2920P05H	\$154.50
6 x 5/8-11	24	DXA2920P06H	\$172.11
7 x 5/8-11	24	DXA2920P07H	\$211.87
9 x 5/8-11	24	DXA2920P09H	\$309.00

**RPM**

4"	15,300
4.5"	13,600
5"	12,225
6"	10,200
7"	8,600
9"	6,600



**TYPE 29 (FINER FINISH)**  
DIAMOND<sup>®</sup>

**Application(s)**

- Weld removal. Finer finish for wide variety of applications



SIZE	GRIT SIZE	PART #	LIST PRICE
4 x 5/8	50	DXA2930P04A	\$103.72
4 1/2 x 5/8-11	50	DXA2930P45H	\$112.58
5 x 5/8-11	50	DXA2930P05H	\$154.50
6 x 5/8-11	50	DXA2930P06H	\$172.11
7 x 5/8-11	50	DXA2930P07H	\$211.87
9 x 5/8-11	50	DXA2930P09H	\$309.00

**RPM**

4"	15,300
4.5"	13,600
5"	12,225
6"	10,200
7"	8,600
9"	6,600



**PIPELINE DISC**  
DIAMOND<sup>®</sup>

**Application(s)**

- All pipeline applications



SIZE	GRIT SIZE	PART #	LIST PRICE
4 x .156 x 5/8	50	DXA2730P04A	\$158.93
4½ x .156 x 5/8-11	50	DXA2730P45H	\$167.79
5 x .156 x 5/8-11	50	DXA2730P05H	\$182.10
6 x .156 x 5/8-11	50	DXA2730P06H	\$253.79
7 x .156 x 5/8-11	50	DXA2730P07H	\$342.06
9 x .156 x 5/8-11	50	DXA2730P09H	\$453.61

**RPM**

4"	15,300
4.5"	13,600
5"	12,225
6"	10,200
7"	8,600
9"	6,600



**FOUNDRY DISC**  
DIAMOND<sup>®</sup>

**Application(s)**

- All ferrous and non-ferrous materials



SIZE	GRIT SIZE	PART #	LIST PRICE
7 x .140 x 5/8-11	36	DXA2725P07H	\$536.32
9 x .140 x 5/8-11	36	DXA2725P09H	\$728.31

**RPM**

7"	8,600
9"	6,600



**CUTTING/GRINDING WHEEL**  
DIAMOND<sup>®</sup>

**Application(s)**

- Foundry-gate/rise removal, forgings, metal pipe, sectional tubing, metal plate, steel bar and ductile iron

\*This blade not for use on STIHL<sup>®</sup> & HUSQVARNA<sup>®</sup> branded saws. STIHL<sup>®</sup> recommends against use of abrasion sided blades on their saws. STIHL<sup>®</sup> is a trademark of Andreas Stihl AG & Co. HUSQVARNA<sup>®</sup> is a trademark of Husqvarna AB.

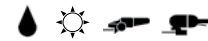

SIZE	GRIT SIZE	PART #	LIST PRICE
4 x .137 x 5/8	36	DXB0125P0414A	\$103.72
4½ x .137 x 5/8	36	DXB0125P4514C	\$112.58
5 x .137 x 7/8	36	DXB0125P0514C	\$143.48
6 x .137 x 7/8	36	DXB0125P0614C	\$154.50
7 x .137 x 7/8	36	DXB0125P0714C	\$187.56
9 x .137 x 7/8	36	DXB0125P0914C	\$280.26

**RPM**

4"	15,300
4.5"	13,600
5"	12,225
6"	10,200
7"	8,600
9"	6,600



**GRINDING DISC  
-REVERSIBLE HARD FACE  
WELDING**  
DIAMOND<sup>®</sup>

**Application(s)**

- Weld removal, pipe beveling, and stock removal of all ferrous and non-ferrous metals including mild steel, stainless steel, alloy steels, ductile materials, hard-face metal alloys and ceramic



SIZE	GRIT SIZE	PART #	LIST PRICE
4 x .250 x 3/8	36	DXA0125P0425A	\$155.63
4 1/2 x .250 x 3/8-11	36	DXA0125P4525H	\$171.08
5 x .250 x 3/8-11	36	DXA0125P0525H	\$191.99
6 x .250 x 3/8-11	36	DXA0125P0625H	\$233.91
7 x .250 x 3/8-11	36	DXA0125P0725H	\$278.10
9 x .250 x 3/8-11	36	DXA0125P0925H	\$360.91



**CUTTING WHEEL**  
DIAMOND<sup>®</sup>

**Application(s)**

- Foundry-gate/rise removal, forgings, sheet metal, pipe, metal plate, round & sectional tubing, steel bar, angle iron, cast iron, ductile iron, metal studs and carbon/mild steel



SIZE	GRIT SIZE	PART #	LIST PRICE
16 x .155 x 1	24	DXE0120P1615E	\$578.24
18 x .155 x 1	24	DXE0120P1815E	\$653.33
20 x .170 x 1	24	DXE0120P2017E	\$838.73
24 x .185 x 1	24	DXE0120P2418E	\$1,492.06
26 x .185 x 1	24	DXE0120P2618E	\$1,898.19
28 x .200 x 1	24	DXE0120P2820E	\$2,410.20
30 x .200 x 1	24	DXE0120P3020E	\$2,675.01







**FS200-13G**  
flat saw

Diamond Vantage Walk Behind Saws are built from the ground up to provide years of reliable cutting. These saws will cut concrete and asphalt with little to no vibration because of their heavy-gauge steel frames, rugged shafts and bearing assemblies.

- Precision machined arbor shafts
- Multiple-belt power transfer system
- Superior rigidity for smooth, clean, straight cuts
- Heavy-Duty 7-gauge steel construction
- Large screw-type depth control locks for consistent cutting depth
- **Part #: FS200-13G**

Blade Capacity	18"
Weight	254 lbs.
Horse Power	13 HP
Dimensions	49" L x 27" W x 40" H
Max Cut Depth	6-3/4"
Motor	Honda



**DV-GCT-8EE**  
Early Entry Saw

- Early Entry Saw with skid plate assembly
- Optional dust box with excellent dust control
- Folding handle with 4 positions for operation and storage
- 1/4" thick welded steel construction
- Durable powder coated finish
- Front and rear blade pointers
- Preset blade depth stop
- Integrated wrench holders
- Made in USA
- **Part #: DV-GCT-8EE**

## GorillaConcreteTools

Blade Capacity	8"
Weight	125 lbs.
Arbor Size	7/8"
RPM	3,600
Cutting Depth	Adjustable up to 2"
Frame Construction	1/4" welded steel
Vacuum Requirements	250 c.f.m. minimum
Dust Port	2"
Motor	Honda GX200



**MDE350**  
masonry saw

The MDE350 Dry Masonry Saw features a powerful 3HP motor and 14" blade capacity for fast cutting of brick/block and general purpose applications. The saw can also be used wet with our optional wet kit. The powerful dust collector kit ensures clean cutting, indoors or out.

- **Part #: MDE350**
- **Stand Part #: MDE350-ST**

Blade Capacity	14"
Weight	75 lbs.
Horse Power	3HP
Arbor Size	1"
RPM	3,600
Max Cut Depth	5"
Rip Cutting	16"
Thermal Protection	Equipped
Motor	115V/60Hz



**DRE4**  
core drill

- 3 speed 19.5 AMP hand-held core drill
- Wet or dry diamond core drill
- Water swivel and extraction port built into the spindle
- Easily switchable from hand-held to stand-mounted drilling
- Drill stand adjustable up to 45 degrees
- Includes drill bit connections 5/8"-11 UNC and 1-1/4"-7 UNC
- **Part #: DRE4**



**DRE4S**  
core drill stand

- Lightweight, robust drill stand
- Available vacuum base (Model DRE4-V) to handle all types of applications (optional, sold separately)
- Stand adjustable up to 45 degrees for angle drilling
- Available with mounting brackets and screws
- **Part #: DRE4-S**

# EIBENSTOCK

Power	19.5AMP/110V
Max Drilling Diameter	6"
Load Speed	
1. Gear 3/4" - 6 3/8"	0-510 RPM
2. Gear 1 3/4" - 3 1/4"	0-1150 RPM
3. Gear 1/2" - 1 1/4"	0-2500 RPM
Spindle Connection	5/8" x 11 UNC & 1 1/4" x 7UNC
Collar Diameter	60mm
Carrying Case Included	yes
Weight	15 lbs

Max Drilling Diameter	6"
Height	30"
Motor Mount	60mm
Drilling Angle	90-45 degrees
Weight (Stand Only)	21 lbs
Base Diameter L x W	15-1/2" x 9"
Anchor or Vacuum Base	Combination



**SMD08**  
core drill

- Motor comes with slip clutch that can be easily adjusted from outside the motor and can be completed on the job site
- Max core bit length of 21" can be installed
- Feed handle can be placed on either right or left side of carriage for easy drilling close to walls and columns
- 4 adjustable leveling screws for drilling uneven surfaces
- Double insulated construction
- Swiveling water valve can be rotated full 360 degrees for added convenience
- Engineered for both vertical & horizontal drilling
- Total weight: 71 lbs. (32.2 kg)
- One-year limited warranty
- Manufactured by Hakken for Diamond Vantage
- **Part #: SMD08-V3**

Optional Items:

- 6" and 12" water collecting ring
- Vacuum Pump, Vacuum Pad, Ceiling Jack



Power	115V, 15A drill motor
Core Bit Capacity	8"
Spindle Thread	1-1/4"-7
Column Thickness	1-15/16"
Stand Height	31-7/8"
Carriage Travel	19-7/8"
Anchor Base	7" W x 8-1/2" L
Clutch Type	Slip
Speed	700 RPM (Single)
Weight	49 lbs (22.2 kg)



**SMD12**  
core drill

- Motor comes with slip clutch that can be easily adjusted from outside the motor and can be completed on the job site
- Max core bit length of 26" can be installed
- Feed handle can be placed on either right or left side of carriage for easy drilling close to walls and columns
- 4 adjustable leveling screws for drilling uneven surfaces
- Double insulated construction
- Swiveling water valve can be rotated full 360 degrees for added convenience
- Engineered for both vertical & horizontal drilling
- Total weight: 95 lbs. (43.1 kg)
- One-year limited warranty
- Manufactured by Hakken for Diamond Vantage
- **Part #: SMD12-V3**

Optional Items:

- 6" and 12" water collecting ring
- Vacuum Pump, Vacuum Pad, Ceiling Jack & Wheels



Power	115V, 20A drill motor
Core Bit Capacity	12"
Spindle Thread	1-1/4"-7
Column Thickness	2-5/16"
Stand Height	39-3/8"
Carriage Travel	24-3/8"
Anchor Base	7.5" W x 10" L
Clutch Type	Slip
Speed	400/950 RPM (Dual)
Weight	68 lbs. (30.8 kg)



**SMD16**  
core drill

- Motor comes with slip clutch that can be easily adjusted from outside the motor and can be completed on the job site
- Max core bit length of 26" can be installed
- Feed handle can be placed on either right or left side of carriage for easy drilling close to walls and columns
- 4 adjustable leveling screws for drilling uneven surfaces
- Double insulated construction
- Swiveling water valve can be rotated full 360 degrees for added convenience
- Engineered for both vertical & horizontal drilling
- Total weight: 95 lbs. (43.1 kg)
- One-year limited warranty
- Manufactured by Hakken for Diamond Vantage
- **Part #: SMD16-V3**

Optional Items:

- 6" and 12" water collecting ring
- Vacuum Pump, Vacuum Pad, Ceiling Jack & Wheels



Power	115V, 20A drill motor
Core Bit Capacity	16 "
Spindle Thread	1-1/4"-7
Column Thickness	2-5/16"
Stand Height	39-3/8"
Carriage Travel	24-3/8"
Anchor Base	7.5" W x 10" L
Clutch Type	Slip
Speed	300/800/1400 RPM (No Load)
Weight	76 lbs. (34.5 kg)

Hakken® drill stands



*standard stand*



*standard stand with large vacuum base*



*swivel stand*



*angled stand*

Hakken® drill water collector ring

DUSTLESS Connector  
*also available for all sizes*

SIZE	PART #
2	SMDWC02
3	SMDWC03
4	SMDWC04
6	SMDWC06
8	SMDWC08
10	SMDWC10
12	SMDWC12
14	SMDWC14
16	SMDWC16





**FG7500**  
planetary grinder

The FG7500 7.5HP grinder is ideal for large residential and medium-sized commercial jobs. It features a planetary grinding system with 3 heads for maximum productivity on large scale jobs. The grinder is powered by a 7.5HP Siemens motor and features ergonomic handles for easy maneuverability. The FG7500 also includes a detachable water tank, adding flexibility for wet or dry grinding. Backed by our industry-leading 3 year/2,500 hour limited warranty.

• Part #: FG7500

Length	39.4"
Width	25"
Height	29.6"
Weight	680 lbs.
Motor Output	7.5 HP
Grinding Head Size	24"
# of Plates	3
Phases	1
Power	220V
# of Speeds	Variable w/ Soft Start



**FG5000**  
planetary grinder

The FG5000 5HP grinder is ideal for medium residential and medium-sized commercial jobs. It features a planetary grinding system with 3 heads for maximum productivity on large scale jobs. The grinder is powered by a 5HP Siemens motor and features ergonomic handles for easy maneuverability. The FG5000 also includes a detachable water tank, adding flexibility for wet or dry grinding. Backed by our industry-leading 3 year/2,500 hour limited warranty.

• Part #: FG5000

Length	38"
Width	21"
Height	26.4"
Weight	454 lbs.
Motor Output	5 HP
Grinding Head Size	20"
# of Plates	3
Phases	1
Power	220V
# of Speeds	Variable w/ Soft Start



**DC3300**  
dust extractor

To ensure a dust-free floor, the DC-3300 dust extractor is a powerful, highly efficient 2 stage vacuum system that collects all sizes of dust particles and prevents clogging by depositing large grit particles into the first canister and the small to medium grit particles in the main canister.

• Part #: DC3300

Width (smaller unit)	22"
Height (smaller unit)	39"
Width (larger unit)	27"
Height (larger unit)	49"
Weight (net)	182 lbs
Cubic Feet Per Minute(CFM)	330
Auto pulse or manual shake	manual
Power	110V / 50Hz 220V (optional)
HEPA	compatible



**DV-GR-K**  
slurry vacuum

- 30 & 50 gallon capacities
- Model available with 4 casters or 2 casters with 2 large pneumatic wheels and a grab handle
- Available with or without drain plug
- 2" headed inlet tube
- Stainless steel screen float enclosure
- 1.5" Steel wand
- Roll cage protection for all components
- Recessed electrical plug, no more cord restraint
- Accessories & other tooling available
- **Part #: 30 Gallon Vacuum: DV-GR-K12**  
**55 Gallon Vacuum: DV-GR-K15**

Motor	120 V 13.5 AMPS
Airflow	104 cfm
Hose	1.5" or 2" x 15'
Vacuum	110 vacuum inches water sealed
Tool	14" squeegee floor tool 6" aluminum utility tool



**DC350LM**  
dust extractor

Introducing our most powerful single-phase dust extractor. Three large, commercial-grade vacuum motors provide 330 CFM and 100" of water lift, which is plenty of power for small to mid-size floor grinders. The DC-350LM is equipped with a drop down dust collection system that has a separator built in to the bottom. The filters are HEPA. The DC-350LM is portable and easy to maneuver on job site floors. All steel construction with large wheels in back and small locking wheels in front. All accessories are included.

- **Part #: DC350LM**

Width	26"
Height	66"
Weight (net)	152 lbs.
Cubic Feet Per Minute(CFM)	330
Auto pulse or manual shake	manual
Power	110V / 50Hz 220V (optional)
HEPA	compatible



**DC150LM**  
dust extractor

- Portable and powerful single phase HEPA dust collector with two motors.
- Connect directly to equipment for dustless grinding and sanding.
- Provides fast recovery of bulk dry dust and debris found on construction abatement and restoration jobs.
- Complies with all OSHA in table 1 requirements.
- **Part #: DC150LM**

Width	22"
Height	58"
Weight (net)	132 lbs.
Cubic Feet Per Minute(CFM)	224
Auto pulse or manual shake	manual
Power	110V / 50Hz 220V (optional)
HEPA	compatible



**EG1000**  
edge grinder

The EG-1000 edge floor grinding machine is ergonomically designed and allows the user to grind in a upright position, helping to eliminate fatigue, backaches, and job site injuries. The most efficient edge grinder in the market. • Operates with 7" hand-held grinder (optional) • Safer operating • Easily connects to a vacuum system • Easy transportation • 45 lbs frame weight • Equipped with headlight for operation in dim areas • Heavy Duty body construction • Control and apply pressure to the center of the tool with guide handle • Easy grinding to the edge. Front arm has multiple position pin to get into tight areas.

• **Part #: EG1000**

Length	25"
Width	23.6"
Height	40.5"
Weight	53 lbs.
Grinding Head Size	7"



**EG500**  
edge grinder

The EG500 is a kneel down edge grinder that is very maneuverable. It's easy one hand operation reduces back ache and shoulder pain. The shroud is designed to not lose suction at any angle even against a wall.

• **Part #: EG500**

Length	24"
Width	12"
Height	10"
Weight	30 lbs.
Grinding Head Size	7"



**DV HAND GRINDER**

**7" Optional Grinder** (DV Hand Grinder)  
(Hand Grinder that attaches to frame)

The DV Hand Grinder is a quality hand-held grinder designed specifically for concrete prep and coatings removal. The heavy-duty design of the DV Hand Grinder provides solid performance when grinding for concrete preparation along walls, around protrusions, and those hard-to-access areas, and offers great dependability for removing epoxies and mastics when utilizing appropriate grinding disks and wheels.

• **Part #: DV-AGS-1000**

Grinding Width	7"
Production Capacity	150/200 sq.ft
Motor	6600 rpm
Voltage	120V, 1ø, 60 Hz
Amperage	15A
Power Cord	6 ft. (1.8m)
Dust Hose Connection	2"
Weight	Net 9 lbs
Dimensions	19" L x 4.5" W x 5" H without handle attached

A hand holding a fountain pen over a document, with a blue vertical bar overlaying the image. The background is a blurred document with horizontal lines. The blue bar is on the right side, and the text is overlaid on it.

**TROUBLE-  
SHOOTING  
POLICY  
WARRANTY**



This troubleshooting guide may help identify, diagnose, resolve and prevent diamond blade problems. The following are samples of some of the problems you may encounter in the field along with potential causes and prevention guides to help diagnose and prevent future problems.

**LOSS OF TENSION**

- CAUSE Blade core has been overheated.
- PREVENTION Provide proper amount of water to both sides of blade. Check to make sure water pump is producing sufficient water flow and that no blockages exist in the water lines.
- CAUSE Blade core has been overheated as a result of the blade spinning on arbor.
- PREVENTION Securely clamp the blade by tightening the flange nut and make certain that the drive pin is functioning on concrete saws.
- CAUSE Blade core has been overheated because of blade core rubbing side of material being cut.
- PREVENTION Properly align saw to permit straight cutting. Avoid twisting the blade in cut. Make certain that shaft RPM is correct, so that blade is operating at its tensioned speed, and consequently runs perfectly straight.
- CAUSE Unequal pressure at blade clamping collars.
- PREVENTION Blade clamping collars should be identical in diameter and the recommended size.

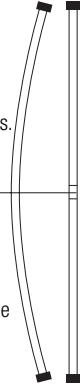

**DO NOT USE A BLADE THAT IS OUT OF TENSION!**

**CRACKS IN STEEL CORE**

- CAUSE Blade flutters in cut as a result of loss of core tension.
- PREVENTION See "Loss of Tension" section.
- CAUSE Blade specification is too hard for material being cut.
- PREVENTION Use softer-bond blade to eliminate stresses which create cracks.



**DO NOT USE A BLADE WITH A CRACKED CORE!**

**UNDERCUTTING**

- CAUSE Abrading or wearing away of the steel center faster than the diamond segment. (Highly abrasive slurry is being generated during cutting.)
- PREVENTION Use as much water as possible to flush out slurry generated during cutting or use wear-retardant cores. CAUTION: Wear-retardant cores are not always the final answer to eliminating undercutting. Care must still be taken to provide sufficient water to the core area immediately adjacent to the segment. This is especially important when making deep cuts.

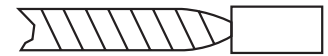

**DO NOT USE A BLADE IF IT IS UNDERCUT!**

**BLADE WOBBLER**

- CAUSE Blade mounted on defective saw.
- PREVENTION Check for bad bearings, bent shaft, or worn mounting arbor. Also, check collars to make sure they are clean, flat, and of the manufacturer's recommended diameter.
- CAUSE Blade being run at improper operating speed.
- PREVENTION Make certain that blade shaft is turning at the recommended RPM to match the tensioned speed of the blade. Use a tachometer on concrete and stone saws to make certain blade shaft is turning and set at the proper speed.
- CAUSE Blade collar diameters are not identical. (Uneven pressure is created on the blade blank at the center.)
- PREVENTION Use proper size blade collars.
- CAUSE Blade bent as a result of dropping or twisting.

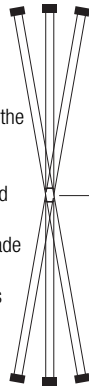

**DO NOT USE A BLADE THAT WOBBLER!**

**ARBOR HOLE OUT OF ROUND**

- CAUSE Blade collar is not properly tightened, permitting blade to either rotate or vibrate on shaft.
- PREVENTION Wrench-tighten arbor nut to make certain blade is adequately secured to prevent rotation on arbor shaft.
- CAUSE Worn or dirty blade collars, which do not allow proper blade clamping.
- PREVENTION Clean blade collars, make sure they are not worn, and tighten arbor nut properly.
- CAUSE Blade not properly mounted.
- PREVENTION Make certain blade is mounted on the proper diameter of the shaft before tightening arbor nut on concrete saw, and make certain that pin holes slide over arbor drive pin. Never depend on drive pin to actually drive the blade. A drive pin is simply a safety measure to prevent the blade from spinning on its mounting arbor, should the nut come loose.

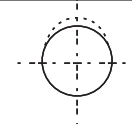

**DO NOT USE A BLADE THAT IS OUT OF ROUND!**

**UNEVEN SEGMENT WEAR**

- CAUSE Insufficient water, generally on one side of the blade, which reduces side clearance.
- PREVENTION Flush water system. Make certain that water is being adequately and equally distributed to both sides of the blade.
- CAUSE Equipment defect, which causes the blade to wear out of round.
- PREVENTION Replace bad bearings, worn arbor shaft, or misaligned shaft on the concrete saw, and make certain the engine runs smoothly to prevent harmonic vibrations, which in turn causes the blade to pound on a regular cycle basis.
- CAUSE Saw head misaligned.
- PREVENTION Check saw head alignment for squareness, both vertically and horizontally.



### SEGMENT LOSS



- CAUSE** The material was not held firmly, which caused the blade to twist or jam in the cut, causing segment loss.
- PREVENTION** Material must be held firmly.
- CAUSE** Overheating due to inadequate supply of water or complete loss of water. This is usually accompanied by discolorations which appear on the steel center in the area of the segment loss.
- PREVENTION** Provide adequate water flow to both sides of the blade, look for line blockages on concrete saw that could cause complete loss of water as a result from equipment running over water feed hoses.
- CAUSE** On the concrete saw the steel center worn thin as a result of undercutting by abrasive slurry generated during cutting. (Core wears to a knife edge, which weakens the weld/braze and causes segment loss).
- PREVENTION** Use sufficient water to flush slurry out of cut. If generated, slurry are highly abrasive and wear-retardant cores / undercut protection should be used.
- CAUSE** Defective blade collars which cause the blade to flutter in the cut or fail to adequately support the blade in perfect alignment.
- PREVENTION** Clean foreign material from blade collar surfaces, or replace collars under manufacturer's recommended diameter.
- CAUSE** Blade is too hard for material being cut causing excessive dullness and the segment separates due to impact or fatigue. (This can also be the cause of frictional heat, which can melt the brazing solder.)
- PREVENTION** Use proper blade specification for the material being cut.
- CAUSE** Blade is cutting out of round resulting in a pounding impact.
- PREVENTION** Replace worn bearings, re-align blade shaft, or replace worn blade-mounting arbor.
- CAUSE** Improper blade tension which produces high pressure on the segments and subsequent failure of the brazed joint (weld).
- PREVENTION** Make sure running speed of the equipment is specified when ordering blades. The spindle speed should be checked with a tachometer to ensure that each diameter blade is running at the manufacturer's recommended cutting speed and blade-tensioned speed.

**DO NOT USE A BLADE WITH A LOST SEGMENT!**

### SHORT LIFE



- CAUSE** Use of a soft-bonded blade for cutting abrasive material, or a cured concrete blade for cutting asphalt or green concrete. There are specific blades designed for each particular material to give the most economical cutting. Also avoid the use of general purpose specifications for cutting a single specific material. General purpose diamond blades are designed to cut a range of materials and, since it is unlikely the operator will be cutting proportionately the proper amount of both hard and soft materials at all times, this is not the economical method of cutting.
- PREVENTION** Use the proper blade specification, as recommended in this catalog.
- CAUSE** Inadequate water to the blade.
- PREVENTION** Make sure water hoses are clean and free from any blockages. Approximately two gallons of water per minute are required to properly cool a saw blade.
- CAUSE** Bad spindle bearings, worn mounting arbor, or misaligned shaft.
- PREVENTION** Replace defective parts.
- CAUSE** Loss of power, resulting from loose drive belts or improper voltage.
- PREVENTION** See instruction manual for proper belt tightening, replace worn belts, and make sure proper line voltage is being supplied to the motor.

### CRACKS IN SEGMENT

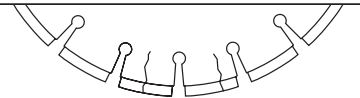

- CAUSE** Blade is too hard for material being cut.
- PREVENTION** Use blade with softer bond.

**DO NOT USE A BLADE WITH A CRACKED SEGMENT!**

### BLADE WILL NOT CUT



- CAUSE** Blade bond is too hard for material being cut. (Improper blade specification.)
- PREVENTION** Consult blade recommendation chart or manufacturer for the proper blade specification for the material being cut.
- CAUSE** Blade has become dull, probably as a result of being used on too hard a material.
- PREVENTION** Dress or sharpen with soft concrete block, piece of sandstone, or in asphalt to expose diamonds. If continual dressing is required, this would indicate that the blade specification is too hard for the material being cut.
- CAUSE** Failure to initially break in new blade on specific material being cut.
- PREVENTION** Allow blade to sharpen itself on the material to be cut when first placing it on the saw. This is the proper way to break in a blade.
- CAUSE** Insufficient power to permit blade to cut properly.
- PREVENTION** Tighten belts in accordance with machine maintenance instruction. Use correct voltage at motor and use adequate horsepower for cutting application.

## SALES POLICY

- **Prices:** Subject to change without notice. Prices in effect at time of shipment are applicable. All prices are in U.S. dollars. Prices quoted are without federal, state or local taxes of any type.
- **Minimum Order:** \$400.00 (excluding freight and taxes)
- **Sales Tax:** Sales tax will be charged where applicable unless a current tax exemption certificate is provided.

## FREIGHT POLICY

### Diamond Tools

- **Orders over \$400.00 net are shipped standard ground FOB destination within the continental U.S., customers to pay freight on all orders less than \$400.00.**
- Requests for 3rd, 2nd, or next day shipments will be billed to the customer.

### Equipment

- All pieces of equipment and parts are shipped by ground/truck with freight prepaid and added to the invoice.

## TRIAL POLICY

- Purchase orders are requested and full payment is expected on all trial blades. Trial blades will be invoiced on the basis of normal ordering, if the trial blades are successful payment in full is expected.
- Trial blades that are unsatisfactory will be issued full or partial credit depending on the usage. The customer and the returns department will determine the efficiency of the trial performance

## RETURNED GOODS POLICY

- All Returns are subject to a minimum 15% restocking fee.
- Discontinued items and items one (1) year or older from the original invoice date cannot be returned.
- The Customer Service Representative will issue a Return Goods Authorization (RGA) number for the return. Freight on returned merchandise must be paid by customer and merchandise must be in resalable condition.
- Customized and special order product cannot be returned.
- Only authorized shipments meeting the follow conditions will be accepted.
  1. RGA#
  2. Reasons for return
  3. Description of goods
  4. Copy of original invoices
- Special order items must be canceled within 30 days of ordering. Customer will be responsible for payment of special order after 30 days from order date.

## TERMS & CONDITIONS

- 3%/15 days, Net 30 days
- **Past due amounts are subject to one percent (1%) per month late charge, where permitted by law.**

## DIAMOND TOOL WARRANTY

- **Laser Welded Blade/Bit Warranty:** If the laser welded bond between the segment and the core or barrel fails during the normal useful life of the product\*, the blade or bit will be replaced free of charge.
- **Brazed Blade/Bit Warranty:** If the brazed welded bond between the segment and the core or barrel fails within the first .050" of segment wear, the blade or bit will be repaired or replaced free of charge.
- **Continuous Rim Blade Warranty:** If the bond between the diamond rim and core fails during the normal useful life of the blade, the blade will be replaced free of charge.

These warranties do not cover abuse to or misapplication of the blade or bit. Our obligation under this warranty is limited to replacement or repair at our Irvine, California facility.

- **Equipment Warranty: Gas Powered Hand Held Saws and Core Drills 90 days, all other Equipment has a One Year Limited Warranty,** except FG7500 and FG5000, which are backed by our industry-leading 3 year/2,500 hour limited warranty.

Diamond Vantage will guarantee every machine we sell to be free from defects in material and workmanship. The obligation of Diamond Vantage under this warranty is limited to the repair or replacement of any parts which, under normal use, prove to be defective in material or workmanship. The parts involved or the unit in question should be returned to Diamond Vantage or to a point designated by us, transportation prepaid.

This warranty does not obligate us to bear the cost of labor or transportation charges in connection with replacement or repair of defective parts. Likewise, it shall NOT apply to any unit which has been subjected to misuse, neglect or accident. This warranty does NOT apply to any machine which has been repaired or altered outside our factory.

This warranty does NOT obligate Diamond Vantage, with respect to items such as engines, motors, hydraulics, etc., which are subject to their own guarantees and warranties provided by the manufacturer.

We shall in no event be liable for consequential damages or contingent liabilities arising out of failure of any equipment or parts associated therewith.

**\*For diamond blades, the above Diamond Tool Warranty is only applicable to blades up to 14" in diameter. For all blades over 14", this warranty is only applicable during the first 50% of segment wear.**



**DV DISPLAY RACK\***

**PART # DV-FLDISPLAY2**



**DV WATER BOTTLE**

**PART # DV-WATERBOTTLE**

\*Blades are not included with display rack



**DV HAT**

**PART # DV-HATBLACK  
PART # DV-HATCAMO**



**DV SAFETY SHIRT**

**PART # SAFETYSHIRTL  
PART # SAFETYSHIRTXL  
PART # SAFETYSHIRTXXL**



**DV COUNTER MAT**

**PART # DV-COUNTERMAT**



**DV PEN & NOTE PAD**

**PART # DV-PEN  
PART # DV-NOTEPAD**









Our primary warehouse and US manufacturing facility is headquartered in Irvine, CA. To better serve our customers, we have selected strategic warehouse locations throughout the USA that will reduce transportation time and cost.

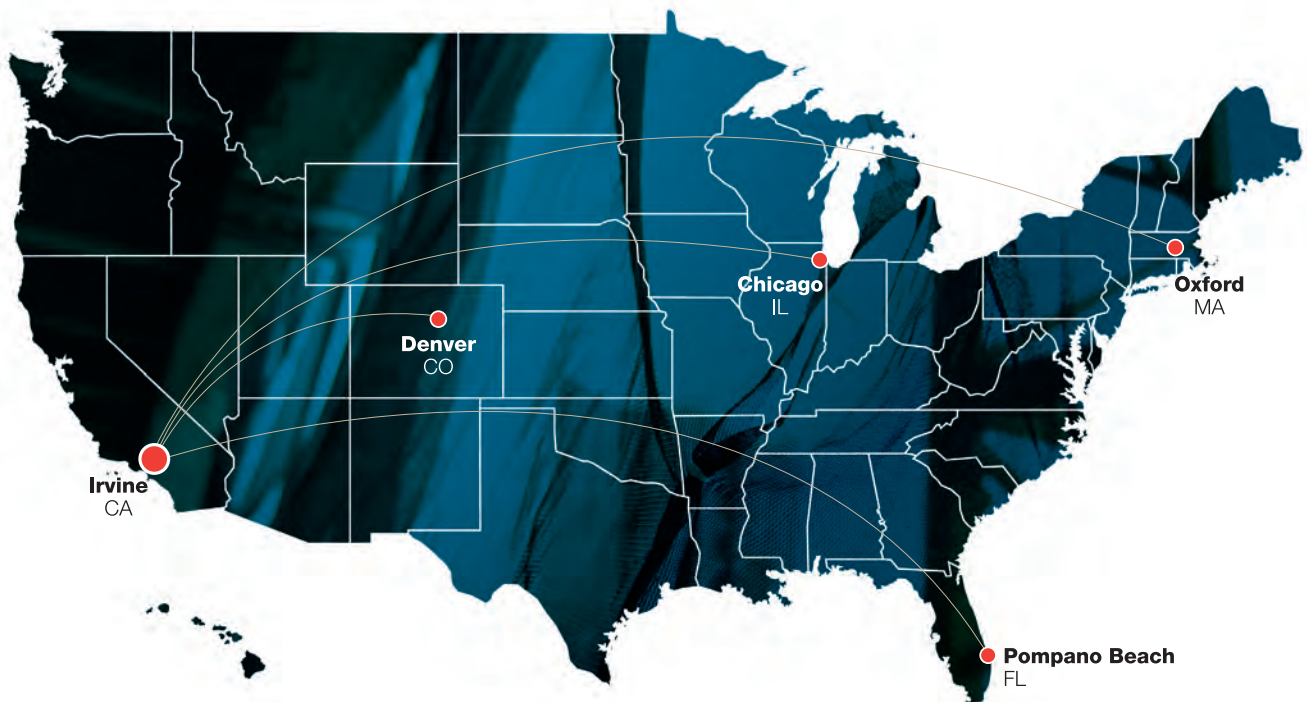



**DIAMONDVANTAGE**

EXPECT THE BEST

[DIAMONDVANTAGE.COM](http://DIAMONDVANTAGE.COM)